

江阴市东方锁业有限公司

江阴东方港晟金属制品有限公司

Jiangyin City Orient Locks Co., Ltd.

Jiangyin Orient Gangsheng Metal Products Co., Ltd.

**JYB<sup>®</sup> 东方锁业**  
**ORIENT LOCKS**

地址：中国江苏省江阴市祝塘镇开发区新圩路 88 号

电话：0086-510-86397858, 86386092 ( 国内部 )

0086-510-86397862 ( 国际部 )

传真：0086-510-86385568

邮箱：511928508@qq.com ( 国内部 )

779618725@qq.com ( 国际部 )

网址：www.dflock.com 邮编：214415

Add: No.88 xinzu road, zhutang town, jiangyin city, jiangsu, china.

Tel: 0086-510-86397862(INTERNATIONAL TRADING DEPT)

0086-510-86397858,86386092(DOMESTIC TRADING DEPT)

Fax: 0086-510-86385568

E-MAIL: 779618725@qq.com(INTERNATIONAL TRADING DEPT)

511928508@qq.com(DOMESTIC TRADING DEPT)

Http://www.dflock.com P.C.: 214415

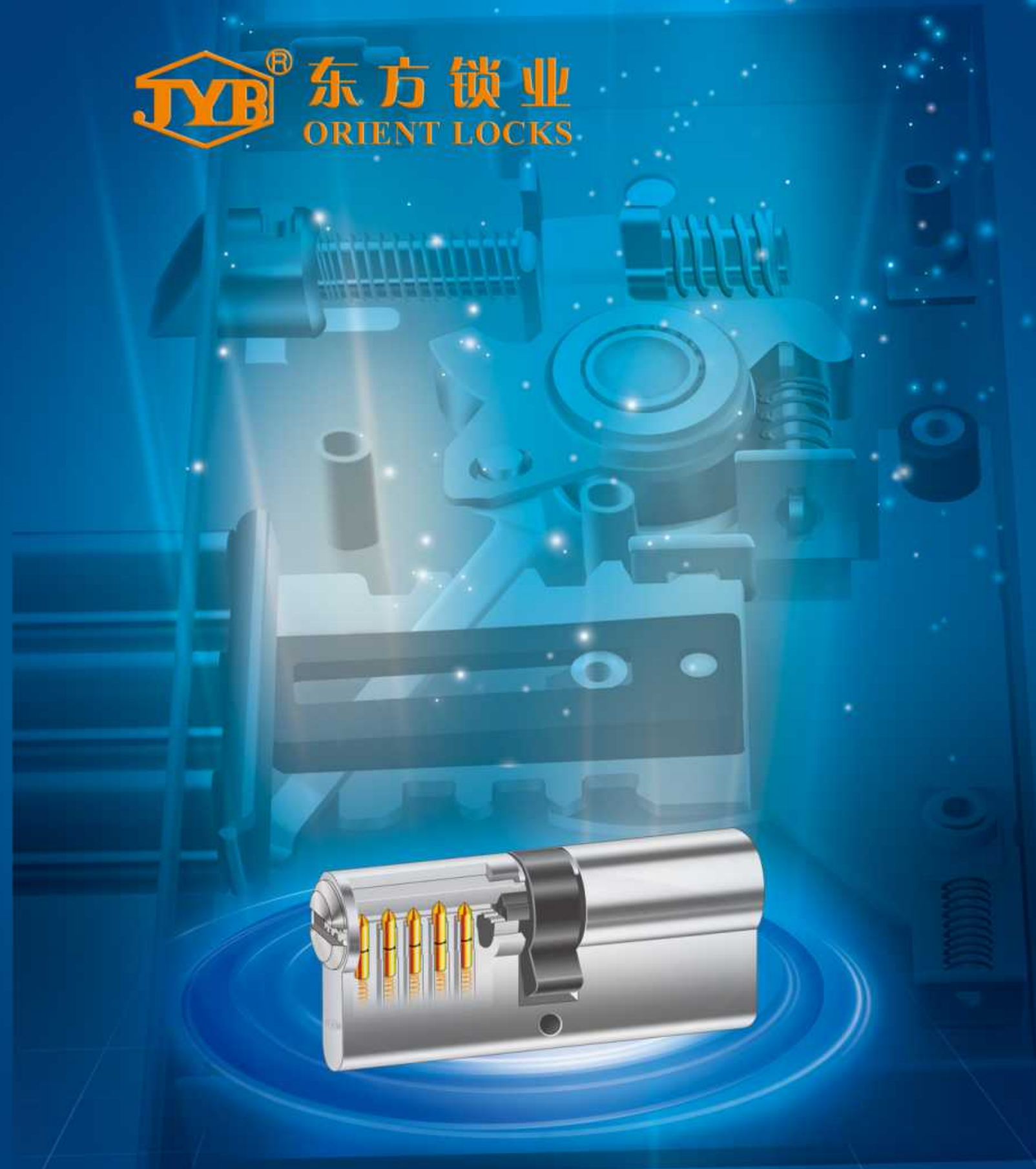



**O**rient Locks, Initiating Civilization life  
Orient Locks, Embellishing Life Diversification



## 产品目录 Contents

- 01 公司简介  
Brief Introduction
- 03 三排珠锁  
Top Security Cylinder Anti-theft
- 04 欧标锁头  
Euro Profile Cylinder
- 10 管理锁  
Master Key Cylinder
- 11 标准锁头  
Standard Cylinder
- 12 锁头表面处理  
Surface Finish
- 13 各式旋钮  
Knob Series
- 14 钥匙槽型  
Key Way
- 15 异形锁头  
Special Cylinder
- 17 铁门锁  
STEEL DOOR LOCKS
- 21 十字钥匙锁  
SECURITY LOCKS WITH CROSS KEYS
- 26 插芯门锁  
MORTISE DOOR LOCKS
- 79 锁体面板处理  
Front Plate Finish



## 公司简介 *Brief Introduction*

Founded in 1998, Jiangyin Orient Gangsheng Metal Products Co.,Ltd.(the former Jiangyin City Orient Locks Co.,Ltd.), covers an area of over 28000 square meters and has more than 500 workers and staff. The company enjoys leading technology, specialized designing talents, excellent digital technology as well as trustful prestige. The company is located in Jiangyin City of the economically developed Yangtze River Delta. Jinghu highway crosses Yanjiang highway in Jiangyin city, with Shanghai being 120km to the east and Nanjing 120km to the west, the company enjoys fast & convenient transportation as well as beautiful landscape.

The company has an annual production capacity of 900000 dozens of various Cylinder and 560000 dozens of various complete locksets and lockbody. It can also design and produce various special locks in accordance with customer's requirements.

Quality is the lifeline for enterprise's survival. Service is the corner stone for the enterprise's development. Customer is the touchstone for discriminating the quality. Your requirements are what we pursue.

Our cylinder has been passed the test by EN1303.2005.

The company is working under the guideline of ISO9001.2008, will develop hand in hand with both old and new customers by means of high quality, beat price and best service.

江阴东方港晟金属制品有限公司（原：江阴市东方锁业有限公司）于 1998 年建成，占地面积 28000 多平方米，公司员工 500 余人。公司拥有领先的技术，专业的设计人才，精良的数控设备，值得信赖的信誉。公司位于风景秀丽、经济发达的长江三角洲江阴市，东至上海、西至南京均为 120 公里，京沪高速、沿江高速贯穿江阴，交通便利。

公司年生产各类锁头 90 万打，各类整套锁具和锁体 56 万打，并可根据用户所需设计制造各类异形锁具。

质量是企业生存的命脉，服务是企业发展的基石，用户是鉴别质量的试金石，你的需要就是我的追求。

公司生产的欧标锁头已通过 EN1303.2005 认证。

本公司将一如既往贯彻 ISO9001.2008 标准，以高品质、低价位及优质的服务与新老客户一起携手发展。



## 设备先进 工艺精良

*Advanced Equipments & Outstanding Technies*

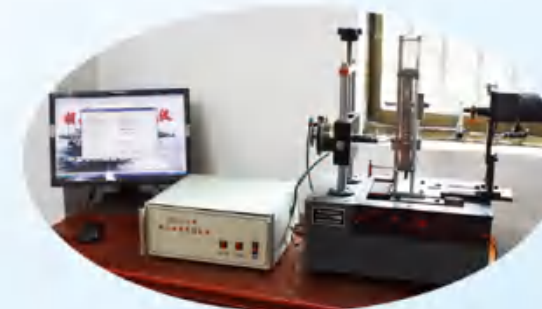





欧标锁头/EURO PROFILE CYLINDER

**EURO PROFILE BRASS EMERGENCY CYLINDER BOTH SIDE OPEN**  
双面开启锁头 “ES-DOU”



BODY: BRASS HPB59-1  
KEY: 3 BRASS KEYS  
CAM: IRON POWDER  
SEAL PIN: 6 PINS, 2 ANTI-DRILL PINS  
SPRING: STAINLESS STEEL  
TS-EN1303:2005

2.2mm



**'ES-DOU' SERIES**

A	B	C	QTY/CTN	G WT	MEAS
			PCS	KGS	CM
60	30	30	120	24	39.5X18.5X16.5
63	31.5	31.5	120	25	39.5X18.5X16.5
68	31	37	120	26.5	39.5X18.5X16.5
70	30	40	120	27	39.5X18.5X16.5
75	30	45	100	24	34X15X19
80	40	40	100	26	34X15X19
85	40	45	100	28	34X15X19
90	45	45	60	20	29.5X24.5X11.5
95	40	55	60	20.5	29.5X24.5X11.5
100	30	70	60	21	29.5X24.5X11.5

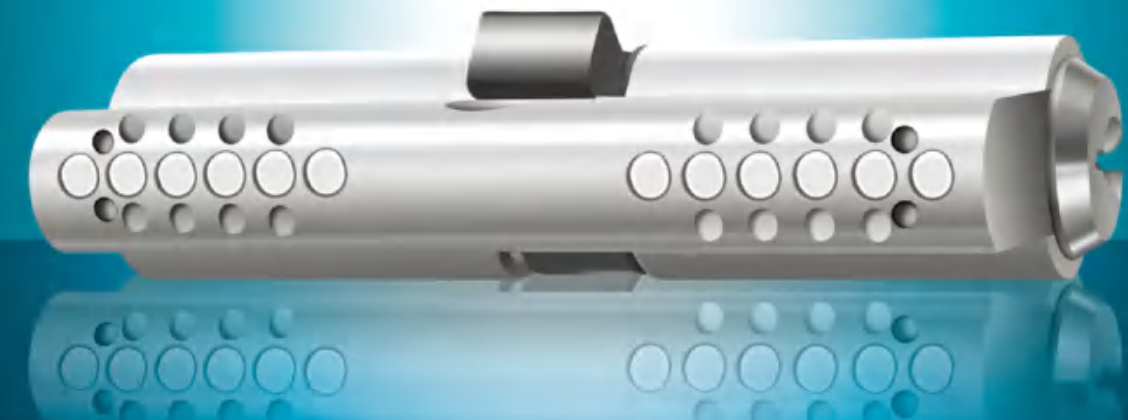

**"F" KEY WAY WITH DOUBLE-LINE SEALING PINS** 'F-KEY WAY' SERIES  
F槽双排珠锁头 “高低槽”



BODY: BRASS HPB59-1  
KEY: 3 BRASS KEYS  
CAM: IRON POWDER  
SEAL PIN: 10 PINS, 2 ANTI-DRILL PINS  
SPRING: STAINLESS STEEL  
TS-EN1303:2005

2.8mm

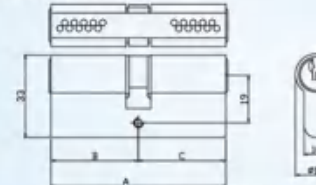

A	B	C	QTY/CTN	G WT	MEAS
			PCS	KGS	CM
60	30	30	120	24	39.5X18.5X16.5
63	31.5	31.5	120	25	39.5X18.5X16.5
68	31	37	120	26.5	39.5X18.5X16.5
70	30	40	120	27	39.5X18.5X16.5
75	30	45	100	24	34X15X19
80	40	40	100	26	34X15X19
85	40	45	100	28	34X15X19
90	45	45	60	20	29.5X24.5X11.5
95	40	55	60	20.5	29.5X24.5X11.5
100	30	70	60	21	29.5X24.5X11.5

**"Y" KEY WAY WITH DOUBLE-LINE SEALING PINS** 'Y-KEY WAY' SERIES  
Y槽双排珠锁头 “直槽”



BODY: BRASS HPB59-1  
KEY: 3 BRASS KEYS  
CAM: IRON POWDER  
SEAL PIN: 10 PINS, 2 ANTI-DRILL PINS  
SPRING: STAINLESS STEEL  
TS-EN1303:2005

2.8mm

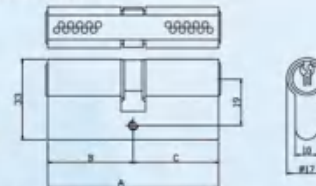

A	B	C	QTY/CTN	G WT	MEAS
			PCS	KGS	CM
60	30	30	120	24	39.5X18.5X16.5
63	31.5	31.5	120	25	39.5X18.5X16.5
68	31	37	120	26.5	39.5X18.5X16.5
70	30	40	120	27	39.5X18.5X16.5
75	30	45	100	24	34X15X19
80	40	40	100	26	34X15X19
85	40	45	100	28	34X15X19
90	45	45	60	20	29.5X24.5X11.5
95	40	55	60	20.5	29.5X24.5X11.5
100	30	70	60	21	29.5X24.5X11.5

**EURO PROFILE HIGH SECURITY CYLINDER WITH DOUBLE LINE PINS** 'EC-DP' SERIES  
双排电脑锁头 “EC-DP”



BODY: BRASS HPB59-1  
KEY: 5 BRASS COMPUTER KEYS  
CAM: IRON POWDER  
SEAL PIN: 10 PINS, 2 ANTI-DRILL PINS  
SPRING: STAINLESS STEEL  
TS-EN1303:2005

2.4mm

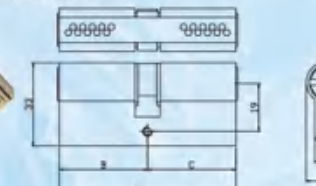

A	B	C	QTY/CTN	G WT	MEAS
			PCS	KGS	CM
60	30	30	50	14.5	49X27X14
63	31.5	31.5	50	15	49X27X14
68	31	37	50	15.5	49X27X14
70	30	40	50	16	49X27X14
75	30	45	50	16.5	49X27X14
80	40	40	50	17	49X27X14

**Top Security Cylinder**  
**Anti-theft**



## 欧标锁头/EURO PROFILE CYLINDER

### EURO PROFILE BRASS CYLINDER WITH TRI-LINE SEALING PINS 'ES-TRI' SERIES 三排珠锁头 "ES-TRI"



BODY: BRASS HPB59-1  
KEY: 3 BRASS KEYS  
CAM: IRON POWDER  
SEAL PIN: 14 PINS, 2 ANTI-DRILL PINS  
SPRING: STAINLESS STEEL  
TS-EN1303:2005

2.2mm

A	B	C	QTY/CTN	G.WT	MEAS
			PCS	KGS	CM
60	30	30	120	24	39.5X18.5X16.5
63	31.5	31.5	120	25	39.5X18.5X16.5
68	31	37	120	26.5	39.5X18.5X16.5
70	30	40	120	27	39.5X18.5X16.5
75	30	45	100	24	34X15X19
80	40	40	100	26	34X15X19
85	40	45	100	28	34X15X19
90	45	45	60	20	29.5X24.5X11.5
95	40	55	60	20.5	29.5X24.5X11.5
100	30	70	60	21	29.5X24.5X11.5

### EURO PROFILE HIGH SECURITY CYLINDER WITH TRI-LINE SEALING PINS 'EC-TRI' SERIES 三排珠电脑锁头 "EC-TRI"



BODY: BRASS HPB59-1  
KEY: 5 BRASS KEYS  
CAM: IRON POWDER  
SEAL PIN: 14 PINS, 2 ANTI-DRILL PINS  
SPRING: STAINLESS STEEL  
TS-EN1303:2005

2.4mm

A	B	C	QTY/CTN	G.WT	MEAS
			PCS	KGS	CM
60	30	30	100	24	39X16X15
63	31.5	31.5	100	25	39X16X15
68	31	37	100	26.5	39X16X15
70	30	40	100	28	39X16X15
75	30	45	100	30	39X16X15
80	40	40	100	32	39X16X15

### EURO PROFILE BRASS CYLINDER WITH BREAKER STRIP 'A' 'ES-BS' SERIES S槽防断锁头



BODY: BRASS HPB59-1  
KEY: 3 BRASS KEYS  
CAM: IRON POWDER  
SEAL PIN: 6 PINS  
SPRING: STAINLESS STEEL  
TS-EN1303:2005

2.2mm

A	B	C	QTY/CTN	G.WT	MEAS
			PCS	KGS	CM
60	30	30	120	24	39.5X18.5X16.5
63	31.5	31.5	120	25	39.5X18.5X16.5
68	31	37	120	26.5	39.5X18.5X16.5
70	30	40	120	27	39.5X18.5X16.5
75	30	45	100	24	34X15X19
80	40	40	100	26	34X15X19
85	40	45	100	28	34X15X19
90	45	45	60	20	29.5X24.5X11.5
95	40	55	60	20.5	29.5X24.5X11.5
100	30	70	60	21	29.5X24.5X11.5

### EURO PROFILE BRASS CYLINDER WITH BREAKER STRIP 'B' 'ES-BS' SERIES 防断锁头

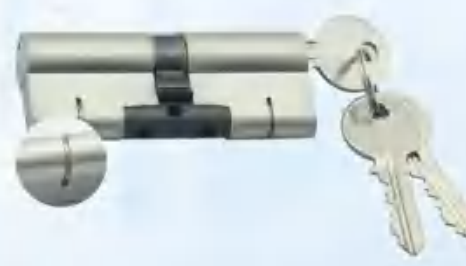

BODY: BRASS HPB59-1  
KEY: 3 BRASS KEYS  
CAM: IRON POWDER  
SEAL PIN: 6 PINS  
SPRING: STAINLESS STEEL  
TS-EN1303:2005

2.2mm

A	B	C	QTY/CTN	G.WT	MEAS
			PCS	KGS	CM
60	30	30	50	15	45X26X15
63	31.5	31.5	50	15.5	45X26X15
68	31	37	50	16	45X26X15
70	30	40	50	16.5	45X26X15
75	30	45	50	17	45X26X15
80	40	40	50	18	45X26X15
85	40	45	50	18.5	45X26X15
90	45	45	50	19.5	45X26X15
95	40	55	50	20	45X26X15
100	30	70	50	21	45X26X15

## 欧标锁头/EURO PROFILE CYLINDER

### EURO PROFILE BRASS CYLINDER WITH BREAKER STRIP 'B' & SNAP 'ES-BS-SNAP' SERIES 防断易断锁头

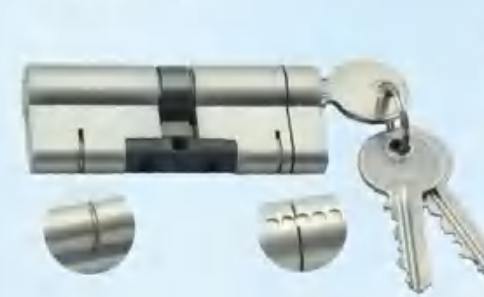

BODY: BRASS HPB59-1  
KEY: 3 BRASS COMPUTER KEYS  
CAM: IRON POWDER  
SEAL PIN: 6 PINS  
SPRING: STAINLESS STEEL  
TS-EN1303:2005

2.2mm

A	B	C	QTY/CTN	G.WT	MEAS
			PCS	KGS	CM
60	30	30	100	24	39X16X15
63	31.5	31.5	100	25	39X16X15
68	31	37	100	26.5	39X16X15
70	30	40	100	28	45X18X17
75	30	45	100	30	45X18X17
80	40	40	100	32	45X18X17

### EURO PROFILE BRASS CYLINDER WITH BREAKER STRIP 'C' & SNAP 'ES-BS-SNAP' SERIES S槽防断易断锁头



BODY: BRASS HPB59-1  
KEY: 3 BRASS KEYS  
CAM: IRON POWDER  
SEAL PIN: 6 PINS, 2 ANTI-DRILL PINS  
SPRING: STAINLESS STEEL  
TS-EN1303:2005

2.2mm

A	B	C	QTY/CTN	G.WT	MEAS
			PCS	KGS	CM
60	30	30	120	24	39.5X18.5X16.5
63	31.5	31.5	120	25	39.5X18.5X16.5
68	31	37	120	26.5	39.5X18.5X16.5
70	30	40	120	27	39.5X18.5X16.5
75	30	45	100	24	34X15X19
80	40	40	100	26	34X15X19
85	40	45	100	28	34X15X19
90	45	45	60	20	29.5X24.5X11.5
95	40	55	60	20.5	29.5X24.5X11.5
100	30	70	60	21	29.5X24.5X11.5

### EURO PROFILE BRASS CYLINDER WITH SNAP 'ES-SNAP' SERIES S槽易断锁头 "ES-SNAP"



BREAKER STRIP: STAINLESS STEEL  
BODY: BRASS HPB59-1  
KEY: 3 BRASS KEYS  
CAM: IRON POWDER  
SEAL PIN: 6 PINS, 2 ANTI-DRILL PINS  
SPRING: STAINLESS STEEL  
TS-EN1303:2005

2.2mm

A	B	C	QTY/CTN	G.WT	MEAS
			PCS	KGS	CM
60	30	30	120	24	39.5X18.5X16.5
63	31.5	31.5	120	25	39.5X18.5X16.5
68	31	37	120	26.5	39.5X18.5X16.5
70	30	40	120	27	39.5X18.5X16.5
75	30	45	100	24	34X15X19
80	40	40	100	26	34X15X19
85	40	45	100	28	34X15X19
90	45	45	60	20	29.5X24.5X11.5
95	40	55	60	20.5	29.5X24.5X11.5
100	30	70	60	21	29.5X24.5X11.5

### EURO PROFILE HIGH SECURITY CYLINDER WITH BREAKER STRIP 'C' 'EC-BS' SERIES 平面槽防断锁头 "EC-BS"



BODY: BRASS HPB59-1  
KEY: 5 BRASS KEYS  
CAM: IRON POWDER  
SEAL PIN: 6 PINS, 2 ANTI-DRILL PINS  
SPRING: STAINLESS STEEL  
TS-EN1303:2005

2.4mm

A	B	C	QTY/CTN	G.WT	MEAS
			PCS	KGS	CM
60	30	30	100	24	39X16X15
63	31.5	31.5	100	25	39X16X15
68	31	37	100	26.5	39X16X15
70	30	40	100	28	45X18X17
75	30	45	100	30	45X18X17
80	40	40	100	32	45X18X17



## 欧标锁头/EURO PROFILE CYLINDER

### EURO PROFILE CYLINDER WITH BREAKER STRIP 'B' SEALING PIN IN UP-SIDE 倒装防断锁头 "EC-UP&BS"

#### 'EC-UP&BS' SERIES



BREAKER STRIP: STAINLESS STEEL  
BODY: BRASS HPB59-1  
KEY: 5 BRASS KEYS 2.4mm  
CAM: IRON POWDER  
SEAL PIN: 6 PINS  
SPRING: STAINLESS STEEL  
TS-EN1303:2005

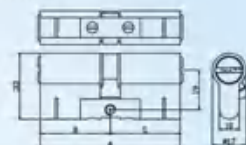

A	B	C	QTY/CTN	G WT	MEAS
			PCS	KGS	CM
60	30	30	100	26	39X16X15
63	31.5	31.5	100	27	39X16X15
66	31	37	100	29	39X16X15
70	30	40	100	30	45X18X17
75	30	45	100	32	45X18X17
80	40	40	100	34	45X18X17

## 欧标锁头/EURO PROFILE CYLINDER

### EURO PROFILE HIGH SECURITY CYLINDER WITH UP-DOWN PINS 上下珠锁头 "EC-UD"



BODY: BRASS HPB59-1  
KEY: 5 BRASS COMPUTER KEYS 2.4mm  
CAM: IRON POWDER  
SEAL PIN: 6 PINS, 2 ANTI-DRILL PINS  
SPRING: STAINLESS STEEL  
TS-EN1303:2005

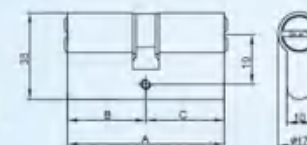

A	B	C	QTY/CTN	G WT	MEAS
			PCS	KGS	CM
60	30	30	100	24	39X16X15
63	31.5	31.5	100	25	39X16X15
66	31	37	100	26.5	39x18x15
70	30	40	100	28	45x18x17
75	30	45	100	30	45x18x17
80	40	40	100	32	45x18x17

### EURO PROFILE BRASS CYLINDER WITH BREAKER STRIP 'C' & SNAP 平面槽防断易断锁头 "EC-BS-SNAP" SERIES



BREAKER STRIP: STAINLESS STEEL  
BODY: BRASS HPB59-1  
KEY: 5 BRASS COMPUTER KEYS 2.4mm  
CAM: IRON POWDER  
SEAL PIN: 6 PINS, 2 ANTI-DRILL PINS  
SPRING: STAINLESS STEEL  
TS-EN1303:2005

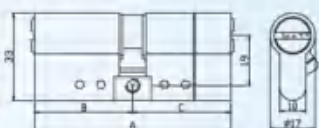

A	B	C	QTY/CTN	G WT	MEAS
			PCS	KGS	CM
60	30	30	100	24	39X16X15
63	31.5	31.5	100	25	39X16X15
66	31	37	100	26.5	39X16X15
70	30	40	100	28	45X18X17
75	30	45	100	30	45X18X17
80	40	40	100	32	45X18X17

### EURO PROFILE CYLINDER SEALING PIN CONCEALING 封口弹子隐藏锁头 "ES-CON" SERIES



BODY: BRASS HPB59-1  
KEY: 3 BRASS KEYS 2.2mm  
CAM: IRON POWDER  
SEAL PIN: 6 PINS  
SPRING: STAINLESS STEEL  
TS-EN1303:2005

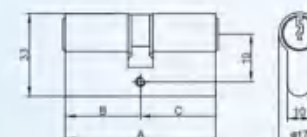

A	B	C	QTY/CTN	G WT	MEAS
			PCS	KGS	CM
60	30	30	120	24	39.5X18.5X16.5
63	31.5	31.5	120	25	39.5X18.5X16.5
66	31	37	120	26.5	39.5X18.5X16.5
70	30	40	120	27	39.5X18.5X16.5
75	30	45	100	24	34X15X19
80	40	40	100	26	34X15X19
85	40	45	100	28	34X15X19
90	45	45	60	20	29.5X24.5X11.5
95	40	55	60	20.5	29.5X24.5X11.5
100	30	70	60	21	29.5X24.5X11.5

### EURO PROFILE BRASS CYLINDER WITH SNAP 平面槽易断锁头 "EC-SNAP" SERIES



BODY: BRASS HPB59-1  
KEY: 5 BRASS COMPUTER KEYS 2.4mm  
CAM: IRON POWDER  
SEAL PIN: 6 PINS, 2 ANTI-DRILL PINS  
SPRING: STAINLESS STEEL  
TS-EN1303:2005

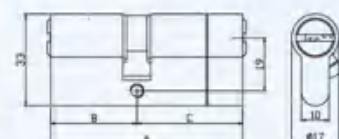

A	B	C	QTY/CTN	G WT	MEAS
			PCS	KGS	CM
60	30	30	100	24	39X16X15
63	31.5	31.5	100	25	39X16X15
66	31	37	100	26.5	39X16X15
70	30	40	100	28	45X18X17
75	30	45	100	30	45X18X17
80	40	40	100	32	45X18X17

### EURO PROFILE CYLINDER SEALING PIN CONCEALING 弹子隐藏锁头平面槽 "EC-CON" SERIES



BODY: BRASS HPB59-1  
KEY: 5 BRASS COMPUTER KEYS 2.4mm  
CAM: IRON POWDER  
SEAL PIN: 6 PINS  
SPRING: STAINLESS STEEL  
TS-EN1303:2005

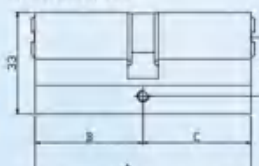

A	B	C	QTY/CTN	G WT	MEAS
			PCS	KGS	CM
60	30	30	100	24	39X16X15
63	31.5	31.5	100	25	39X16X15
66	31	37	100	26.5	39x18x15
70	30	40	100	28	45x18x17
75	30	45	100	30	45x18x17
80	40	40	100	32	45x18x17

### EURO PROFILE BRASS CYLINDER SEALING PIN IN UP-SIDE 倒装锁头 "ES-UP" SERIES



BODY: BRASS HPB59-1  
KEY: 3 BRASS KEYS 2.2mm  
CAM: IRON POWDER  
SEAL PIN: 6 PINS  
SPRING: STAINLESS STEEL  
TS-EN1303:2005

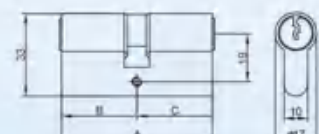

A	B	C	QTY/CTN	G WT	MEAS
			PCS	KGS	CM
60	30	30	120	24	39.5X18.5X16.5
63	31.5	31.5	120	25	39.5X18.5X16.5
66	31	37	120	26.5	39.5X18.5X16.5
70	30	40	120	27	39.5X18.5X16.5
75	30	45	100	24	34X15X19
80	40	40	100	26	34X15X19
85	40	45	100	28	34X15X19
90	45	45	60	20	29.5X24.5X11.5
95	40	55	60	20.5	29.5X24.5X11.5
100	30	70	60	21	29.5X24.5X11.5

### EURO PROFILE HIGH SECURITY ENGINEERING CYLINDER WITH KEY A/B/C 工程锁 EC-A/B/C锁



BODY: BRASS HPB59-1  
KEY: 8 BRASS COMPUTER KEYS 3.0mm  
CAM: IRON POWDER  
SEAL PIN: 7 PINS, 2 ANTI-DRILL PINS  
SPRING: STAINLESS STEEL



A	B	C	QTY/CTN	G WT	MEAS
			PCS	KGS	CM
60	30	30	60	15.5	56X27X26
63	31.5	31.5	60	16	56X27X26
66	31	37	60	17	56X27X26
70	30	40	60	17.5	56X27X26
75	30	45	60	18.5	56X27X26
80	40	40	60	15	56X27X26
85	40	45	60	16.5	56X27X26
90	45	45	60	18	56X27X26
95	40	55	60	20	56X27X26
100	30	70	60	22.5	56X27X26



## 欧标锁头/EURO PROFILE CYLINDER

### EURO PROFILE BRASS CYLINDER 'ES' SERIES

#### 欧标锁头 "ES"



BODY: BRASS HPB59-1  
KEY: 3 BRASS KEYS  
CAM: IRON POWDER  
SEAL PIN: 6 PINS, 2 ANTI-DRILL PINS  
SPRING: STAINLESS STEEL  
TS-EN1303:2005

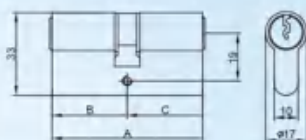

A	B	C	QTY/CTN	G WT	MEAS
			PCS	KGS	CM
60	30	30	100	22	40X15X19
63	31.5	31.5	100	22.5	40X15X19
68	31	37	100	23	40X15X19
70	30	40	100	24.5	40X15X19
75	30	45	100	26	40X15X19
80	40	40	100	27.5	40X15X19
85	40	45	100	29	40X15X19
90	45	45	100	30.5	40X17X24
95	40	55	100	31	40X17X24
100	30	70	100	33.5	40X17X24

### EURO PROFILE BRASS CYLINDER WITH KNOB 'ES' SERIES WITH KNOB

#### 带旋钮欧标锁头 "ES" 带旋钮



BODY: BRASS HPB59-1  
KEY: 3 BRASS KEYS  
CAM: IRON POWDER  
SEAL PIN: 6 PINS, 1 ANTI-DRILL PINS  
SPRING: STAINLESS STEEL  
TS-EN1303:2005

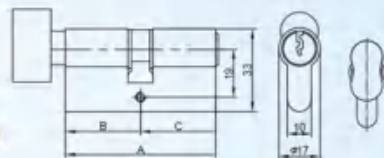

A	B	C	QTY/CTN	G WT	MEAS
			PCS	KGS	CM
60	30	30	100	27	45X19X20
63	31.5	31.5	100	27.5	45X19X20
68	31	37	100	29	45X19X20
70	30	40	100	30	45X19X20
75	30	45	100	32	45X19X20
80	40	40	100	33.5	45X19X26
85	40	45	100	35	45X19X26
90	45	45	100	37	45X19X26
95	40	55	100	38.5	45X19X26
100	30	70	100	40	45X19X26

### EURO PROFILE HIGH SECURITY CYLINDER 'EC' SERIES

#### 欧标电脑锁头 "EC"



BODY: BRASS HPB59-1  
KEY: 5 BRASS COMPUTER KEYS  
CAM: IRON POWDER  
SEAL PIN: 6 PINS, 2 ANTI-DRILL PINS  
SPRING: STAINLESS STEEL  
TS-EN1303:2005

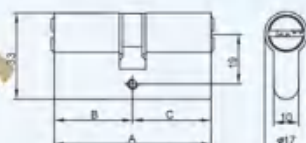

A	B	C	QTY/CTN	G WT	MEAS
			PCS	KGS	CM
60	30	30	100	26.5	45X16X15
63	31.5	31.5	100	27	45X16X15
68	31	37	100	28	40X17X19
70	30	40	100	29	40X17X19
75	30	45	100	31	40X17X19
80	40	40	100	32	40X17X19

### EURO PROFILE HIGH SECURITY CYLINDER WITH KNOB 'EC' SERIES WITH KNOB

#### 带旋钮欧标电脑锁头 "EC" 带旋钮



BODY: BRASS HPB59-1  
KEY: 5 BRASS COMPUTER KEYS  
CAM: IRON POWDER  
SEAL PIN: 6 PINS, 1 ANTI-DRILL PINS  
SPRING: STAINLESS STEEL  
TS-EN1303:2005

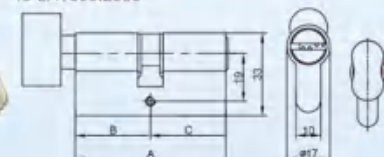

A	B	C	QTY/CTN	G WT	MEAS
			PCS	KGS	CM
60	30	30	100	32	39X17X21
63	31.5	31.5	100	33	39X17X21
68	31	37	100	34	39X17X21
70	30	40	100	35	45X18X21
75	30	45	100	36.5	45X18X21
80	40	40	100	37.5	45X18X25

## 管理锁/MASTER KEY CYLINDER

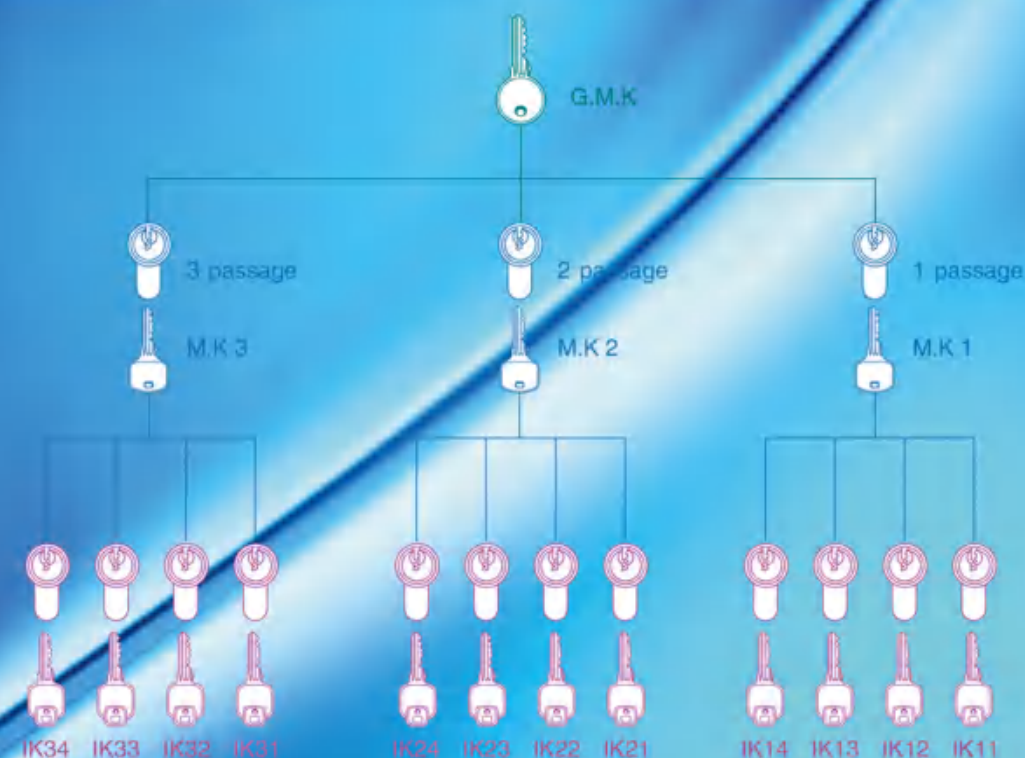
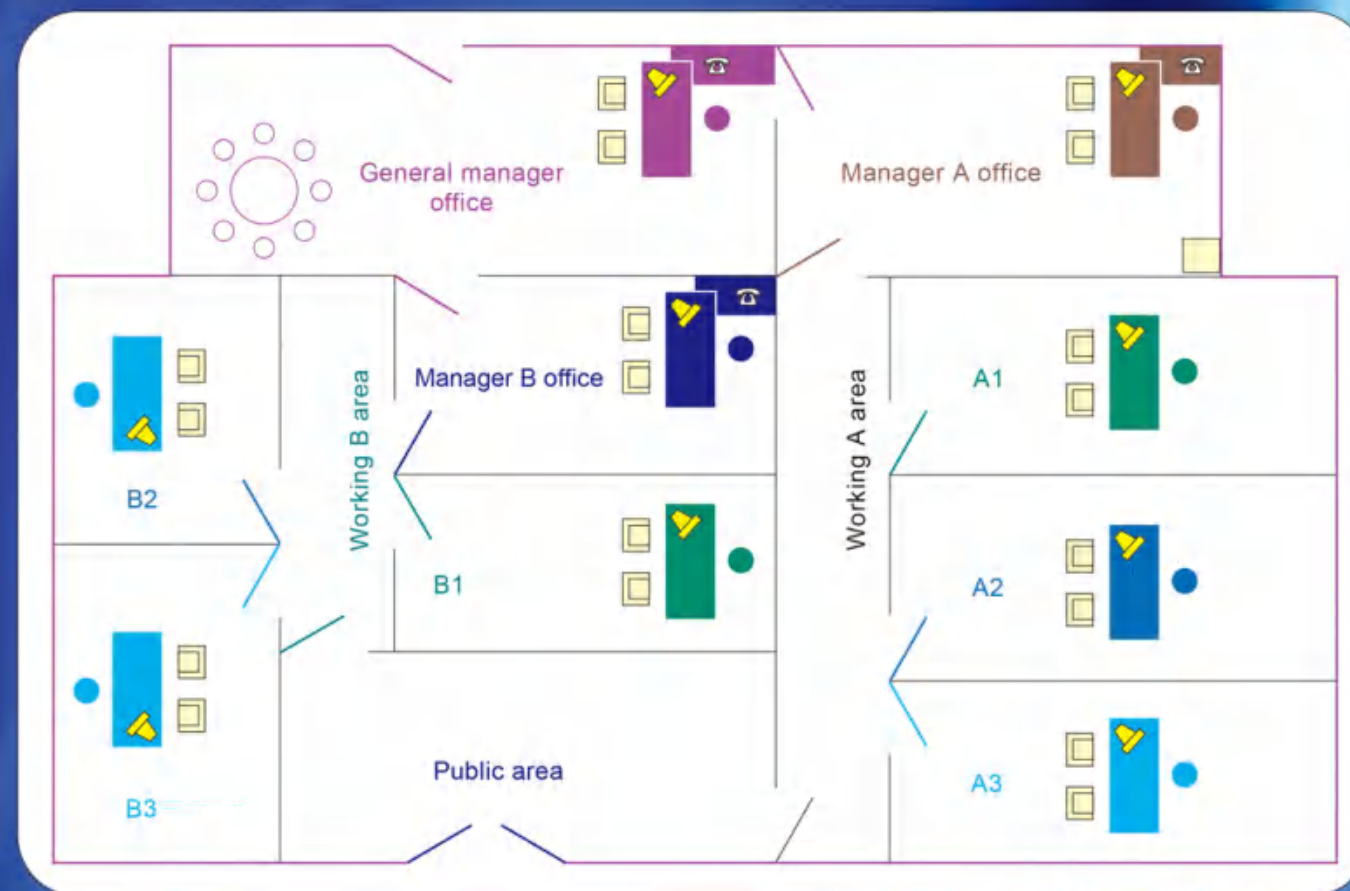

Each master key can open the public door, storey passage door and it's own individual door



## 标准锁头/STANDARD CYLINDER

### STANDARD CYLINDER 'S' SERIES 标准锁头 S槽



BODY: BRASS HPB59-1  
KEY: 3 BRASS KEYS  
CAM: IRON POWDER  
SEAL PIN: 5 PINS  
SPRING: STEEL

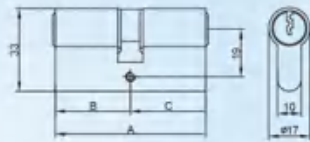

A	B	C	QTY/CTN	G WT	MEAS
			PCS	KGS	CM
60	30	30	100	19	40X15X17
63	31.5	31.5	100	19.5	40X15X17
68	31	37	100	20.5	40X15X17
70	30	40	100	21	40X15X17
75	30	45	100	22	40X15X17
80	40	40	100	25	40X15X23
85	40	45	100	26	40X15X23
90	45	45	100	27.5	40X15X23
95	40	55	100	29	40X15X23
100	30	70	100	30	40X15X23

### STANDARD CYLINDER WITH KNOB 'S' SERIES WITH KNOB 带旋钮标准锁头 S槽带旋钮



BODY: BRASS HPB59-1  
KEY: 3 BRASS KEYS  
CAM: IRON POWDER  
SEAL PIN: 5 PINS  
SPRING: STEEL

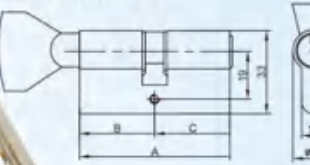

A	B	C	QTY/CTN	G WT	MEAS
			PCS	KGS	CM
60	30	30	100	23	45X18X26
63	31.5	31.5	100	23.5	45X18X26
68	31	37	100	25	45X18X26
70	30	40	100	25.5	45X18X26
75	30	45	100	27	45X18X26
80	40	40	100	28	45X18X26
85	40	45	100	29	45X18X26
90	45	45	100	30	42X16X25
95	40	55	100	31.5	42X16X25
100	30	70	100	34	42X16X25

### HIGH SECURITY CYLINDER 'C' SERIES 电脑锁头 平面槽



BODY: BRASS HPB59-1  
KEY: 5 BRASS COMPUTER KEYS 2.4mm  
CAM: IRON POWDER  
SEAL PIN: 5 PINS  
SPRING: STEEL



A	B	C	QTY/CTN	G WT	MEAS
			PCS	KGS	CM
60	30	30	100	25	45x18x17
63	31.5	31.5	100	25.5	45x18x17
68	31	37	100	27	45x18x17
70	30	40	100	27.5	45x18x17
75	30	45	100	29	45x18x17
80	40	40	100	30	45x18x22

### HIGH SECURITY CYLINDER WITH KNOB 'C' SERIES WITH KNOB 带旋钮电脑锁头 平面槽带旋钮



BODY: BRASS HPB59-1  
KEY: 5 BRASS COMPUTER KEYS 2.4mm  
CAM: IRON POWDER  
SEAL PIN: 5 PINS  
SPRING: STEEL



A	B	C	QTY/CTN	G WT	MEAS
			PCS	KGS	CM
60	30	30	100	29	53X17X22
63	31.5	31.5	100	31	53X17X22
68	31	37	100	32.5	53X17X22
70	30	40	100	33	45X18X26
75	30	45	100	35	45X18X26
80	40	40	100	37	45X18X26

## 锁头表面处理/SURFACE FINISH



环氧树脂研磨上漆 SBP  
Sandy Brass Painting



抛光上漆 ZG  
Zheng Guang



旧铜色 OB  
Original Brass



石子研磨上漆 SSP  
Stone Sandy&Painting



研磨 SB  
Sandy Brass



铜拉丝上漆 BBP  
Brass Brushed Painting



铬拉丝 BCP  
Brushed Chrome Plated



镍拉丝 BNP  
Brushed Nickel Plated



抛丸  
Mat



镀镍 NP  
Nickel Plated



不锈钢色 SS  
Stainless Steel



研磨镀镍 SNP  
Sandy Nickel Plated



沙丁镍 SN  
Satin Nickel



镀铬 CP  
Chrome Plated

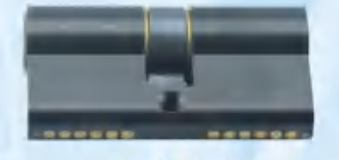

黑塑 BPP  
Black Plastic Painting



红古铜 A/C  
Antique Copper



青古铜 A/B  
Antique Brass



黑镍 BN  
Black Nickel Plated



各类旋钮/KNOB SERIES

<b>梯形 A</b> 	<b>椭圆形 B</b> 
<b>扇形 C</b> 	<b>大圆柱 D</b> 
<b>大三角 E</b> 	<b>帽子形 F</b> 
<b>菱形 G</b> 	<b>椭圆形 H</b> 
<b>扁形 I</b> 	<b>圆形 J</b> 
<b>花生形 L</b> 	<b>椭圆形 N</b> 
<b>椭圆形 O</b> 	<b>锌合金三角形 Q</b> 

钥匙槽型  
key way

S槽						
	S01	S02	S03	S04	S05	S06
S槽						
	S10	S11	S12	S13	S14	S15
电脑槽						
	M01	M02	M04	M05	M06	M08
电脑槽						
	M09	M10	M11	M12	M15	
双排槽						
	S08	S09	M07			



异形锁头/SPECIAL CYLINDER

小椭圆/Small Oval Cylinder

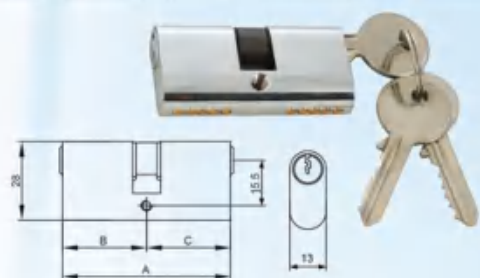

双拔轮旋钮小椭圆/Oval Cylinder with two cams & knob

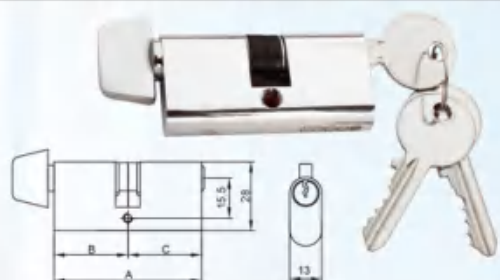

大椭圆/Big Oval Cylinder

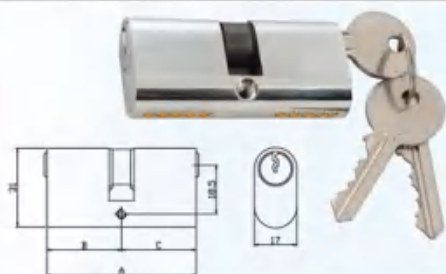

齿轮锁/Gear Cylinder

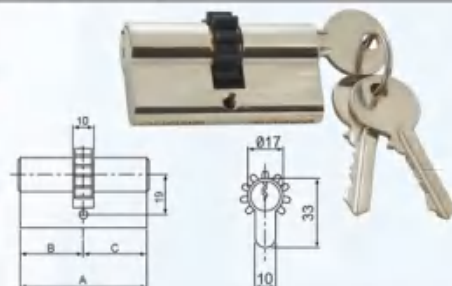

齿轮电脑锁/Computer Gear Cylinder

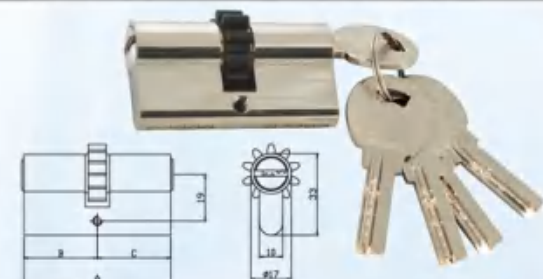

卫浴锁/Bath Room Cylinder

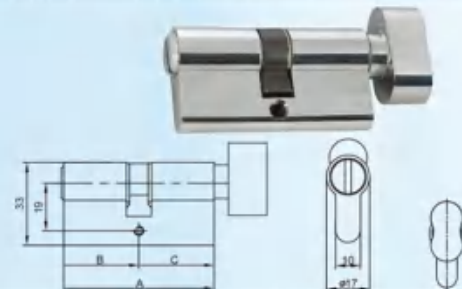

葫芦形单开锁头/Single Open Cylinder

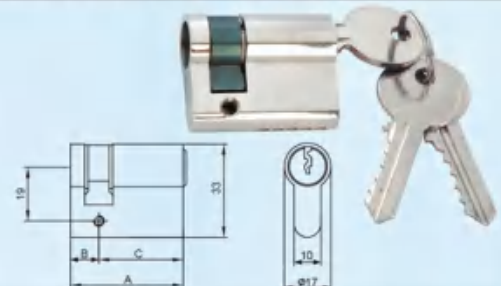

小椭圆单开锁头/Single Open Oval Cylinder

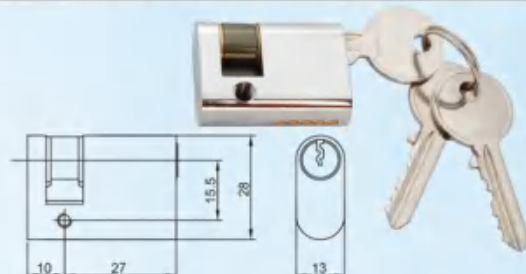

圆锁/Rim Lock Cylinder

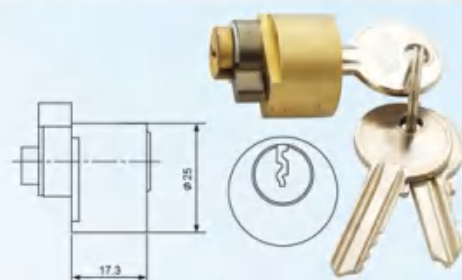

铝对锁/A Pair Of Aluminium Cylinder



JYB<sup>®</sup> ORIENT LOCKS

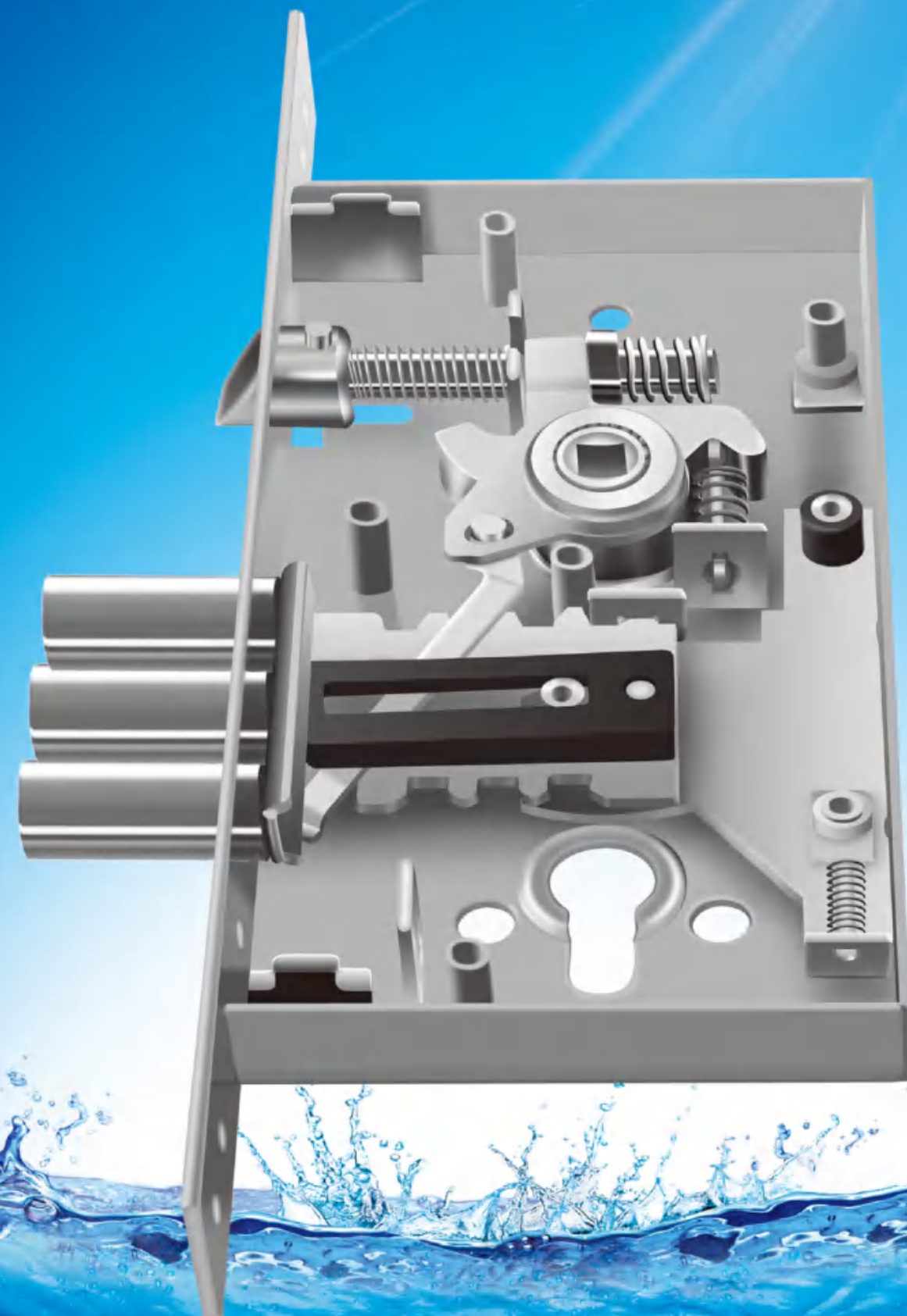



### 252RW



\*close type

货号	中心距	边距	方舌	斜舌	方孔	外箱尺寸	数量/箱	毛重/箱	
	CENTRE	BACK SIDE	DEAD BOLT	LATCH	SPINDLE HOLE	MEAS.	QTY/CTN	G.WT	
	(mm)	(mm)	MATERIAL	MATERIAL	MATERIAL	side length	(PCS)	(KGS)	
252RW	85	60	3ROD	steel	zinc	8X8	34x29x18	10	15.5

### 252L



货号	中心距	边距	方舌	斜舌	方孔	外箱尺寸	数量/箱	毛重/箱	
	CENTRE	BACK SIDE	DEAD BOLT	LATCH	SPINDLE HOLE	MEAS.	QTY/CTN	G.WT	
	(mm)	(mm)	MATERIAL	MATERIAL	MATERIAL	side length	(PCS)	(KGS)	
252L	85	60	3ROD	steel	zinc	8X8	34x29x18	10	16.5

### 252RA

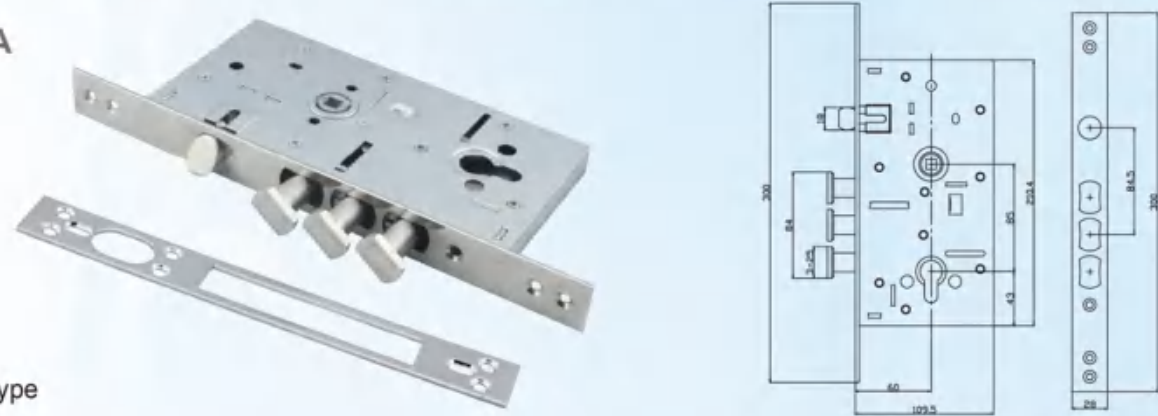

\*close type

货号	中心距	边距	方舌	斜舌	方孔	外箱尺寸	数量/箱	毛重/箱	
	CENTRE	BACK SIDE	DEAD BOLT	LATCH	SPINDLE HOLE	MEAS.	QTY/CTN	G.WT	
	(mm)	(mm)	MATERIAL	MATERIAL	MATERIAL	side length	(PCS)	(KGS)	
252RA	85	60	3ROD	steel	zinc	8X8	34x19x28	10	16

### 257L



\*close type

货号	中心距	边距	方舌	斜舌	方孔	外箱尺寸	数量/箱	毛重/箱
	CENTRE	BACK SIDE	DEAD BOLT	LATCH	SPINDLE HOLE	MEAS.	QTY/CTN	G.WT
	(mm)	(mm)	MATERIAL	MATERIAL	MATERIAL	side length	(PCS)	(KGS)
257L	/	60	3ROD	/	/	27x26x17	10	15

### 257RW

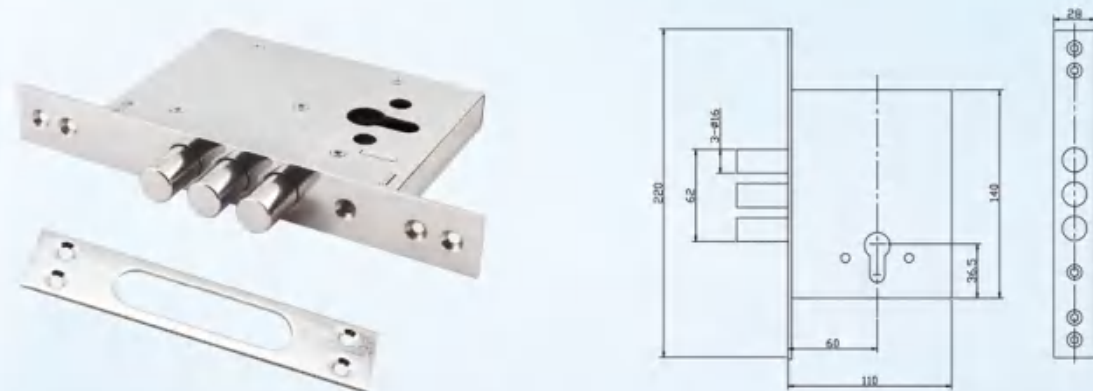

\*close type

货号	中心距	边距	方舌	斜舌	方孔	外箱尺寸	数量/箱	毛重/箱
	CENTRE	BACK SIDE	DEAD BOLT	LATCH	SPINDLE HOLE	MEAS.	QTY/CTN	G.WT
	(mm)	(mm)	MATERIAL	MATERIAL	MATERIAL	side length	(PCS)	(KGS)
257RW	/	60	3ROD	/	/	28x26x17	10	10.5

### 267

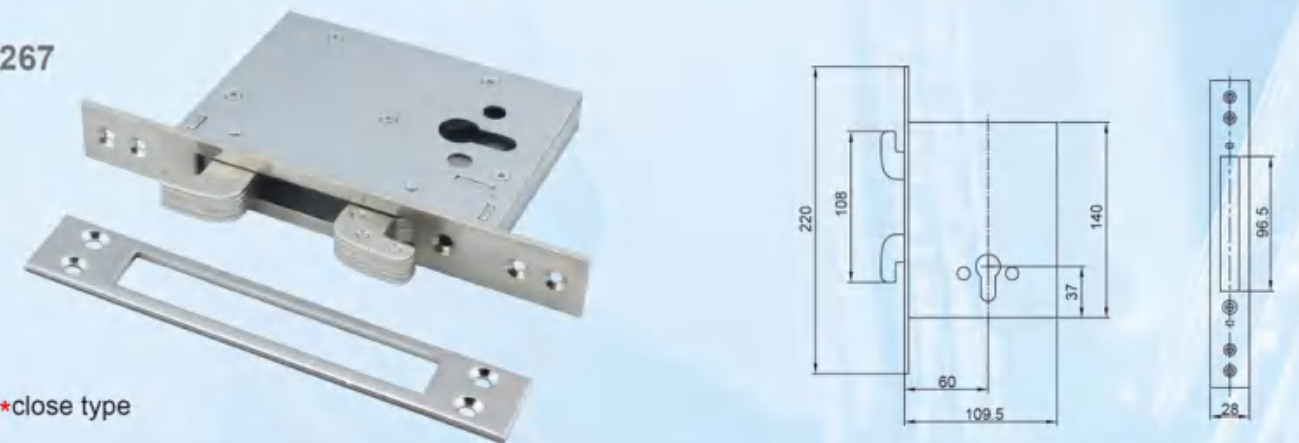

\*close type

货号	中心距	边距	方舌	斜舌	方孔	外箱尺寸	数量/箱	毛重/箱
	CENTRE	BACK SIDE	DEAD BOLT	LATCH	SPINDLE HOLE	MEAS.	QTY/CTN	G.WT
	(mm)	(mm)	MATERIAL	MATERIAL	MATERIAL	side length	(PCS)	(KGS)
267	/	60	2 steel hook	/	/	25.5x25x17	10	11







102

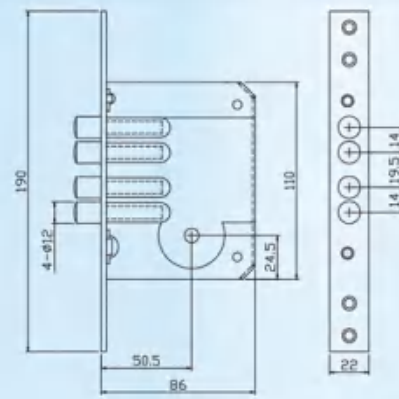

\*close type

货号	中心距	边距	方舌	斜舌	方 孔	外箱尺寸	数量/箱	毛重/箱
	CENTRE	BACK SIDE	DEAD BOLT	LATCH	SPINDLE HOLE	MEAS.	QTY/CTN	G.WT
	(mm)	(mm)	MATERIAL	MATERIAL	MATERIAL	side length (CM)	(PCS)	(KGS)
102	/	50.5	4ROD	/	/	42x30x14	30	23.5

103C

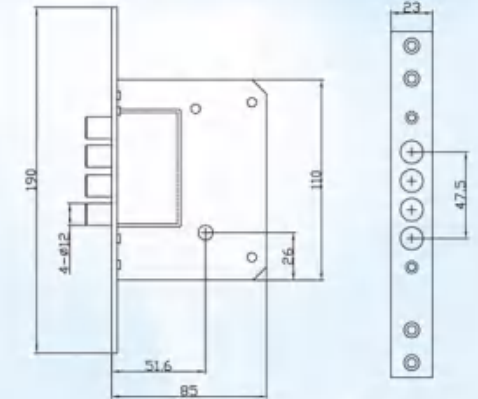

\*close type

货号	中心距	边距	方舌	斜舌	方 孔	外箱尺寸	数量/箱	毛重/箱
	CENTRE	BACK SIDE	DEAD BOLT	LATCH	SPINDLE HOLE	MEAS.	QTY/CTN	G.WT
	(mm)	(mm)	MATERIAL	MATERIAL	MATERIAL	side length (CM)	(PCS)	(KGS)
103C	/	51.6	4 ROD	/	/	42x30x14	30	24.5

102A

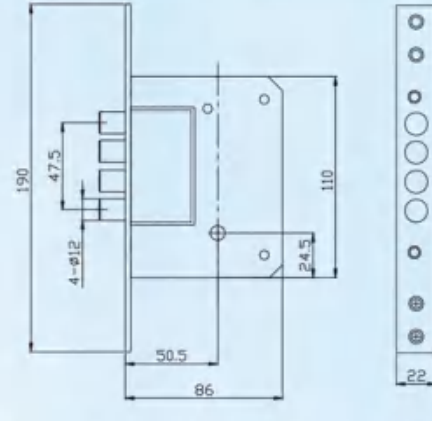

\*half close type

货号	中心距	边距	方舌	斜舌	方 孔	外箱尺寸	数量/箱	毛重/箱
	CENTRE	BACK SIDE	DEAD BOLT	LATCH	SPINDLE HOLE	MEAS.	QTY/CTN	G.WT
	(mm)	(mm)	MATERIAL	MATERIAL	MATERIAL	side length (CM)	(PCS)	(KGS)
102A	/	50.5	4ROD	/	/	42x30x14	30	24

189-3MS

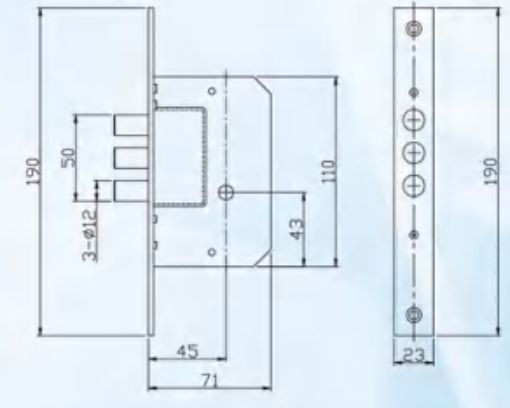

\*half close type

货号	中心距	边距	方舌	斜舌	方 孔	外箱尺寸	数量/箱	毛重/箱
	CENTRE	BACK SIDE	DEAD BOLT	LATCH	SPINDLE HOLE	MEAS.	QTY/CTN	G.WT
	(mm)	(mm)	MATERIAL	MATERIAL	MATERIAL	side length (CM)	(PCS)	(KGS)
189-3MS	/	45	3 ROD	/	/	43x29x14	30	19.5

102C

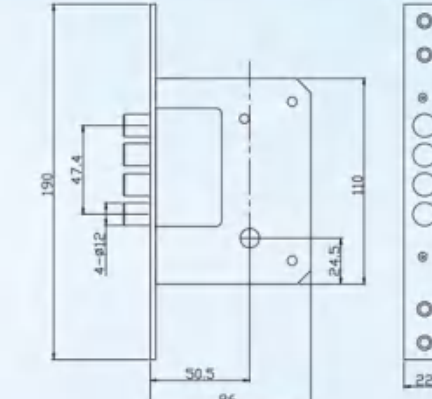

\*close type

货号	中心距	边距	方舌	斜舌	方 孔	外箱尺寸	数量/箱	毛重/箱
	CENTRE	BACK SIDE	DEAD BOLT	LATCH	SPINDLE HOLE	MEAS.	QTY/CTN	G.WT
	(mm)	(mm)	MATERIAL	MATERIAL	MATERIAL	side length (CM)	(PCS)	(KGS)
102C	/	50.5	4ROD	/	/	42x30x14	30	24.5

189-4MF

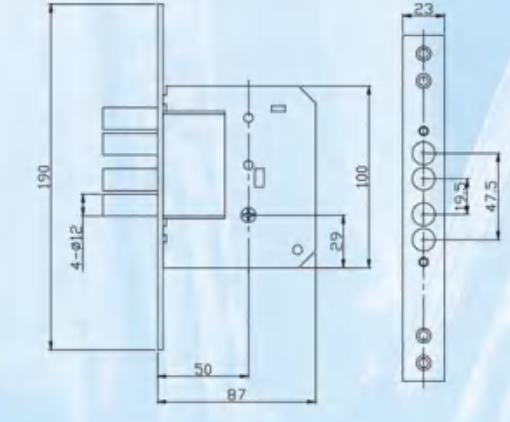

\*close type

货号	中心距	边距	方舌	斜舌	方 孔	外箱尺寸	数量/箱	毛重/箱
	CENTRE	BACK SIDE	DEAD BOLT	LATCH	SPINDLE HOLE	MEAS.	QTY/CTN	G.WT
	(mm)	(mm)	MATERIAL	MATERIAL	MATERIAL	side length (CM)	(PCS)	(KGS)
189-4MF	/	50	4 ROD	/	/	42x30x14	30	20



### 189F-3D



\*open type

货号	中心距	边距	方舌	斜舌	方孔	外箱尺寸	数量/箱	毛重/箱
	CENTRE	BACK SIDE	DEAD BOLT	LATCH	SPINDLE HOLE	MEAS.	QTY/CTN	G.WT
	(mm)	(mm)	MATERIAL	MATERIAL	MATERIAL	side length	(PCS)	(KGS)
189F-3D	/	35	brass	/	/	43X30X14	30	18

### 900A

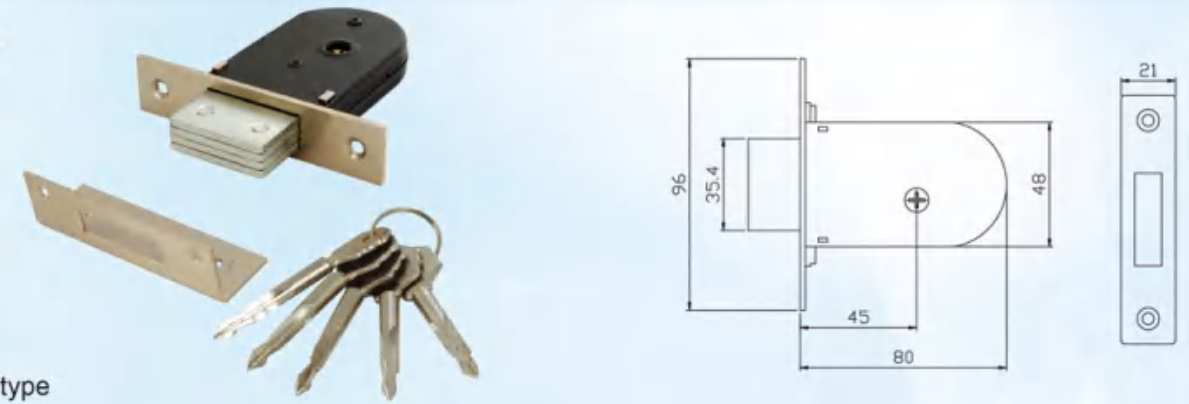

\*close type

货号	中心距	边距	方舌	斜舌	方孔	外箱尺寸	数量/箱	毛重/箱
	CENTRE	BACK SIDE	DEAD BOLT	LATCH	SPINDLE HOLE	MEAS.	QTY/CTN	G.WT
	(mm)	(mm)	MATERIAL	MATERIAL	MATERIAL	side length	(PCS)	(KGS)
900A	/	45	iron	/	/	53x22x22	60	25

### 6025S



\*open type

货号	中心距	边距	方舌	斜舌	方孔	外箱尺寸	数量/箱	毛重/箱
	CENTRE	BACK SIDE	DEAD BOLT	LATCH	SPINDLE HOLE	MEAS.	QTY/CTN	G.WT
	(mm)	(mm)	MATERIAL	MATERIAL	MATERIAL	side length	(PCS)	(KGS)
6025S	/	20	/	zinc hook	/	33x21x21	30	14

### 900AF



\*close type

货号	中心距	边距	方舌	斜舌	方孔	外箱尺寸	数量/箱	毛重/箱
	CENTRE	BACK SIDE	DEAD BOLT	LATCH	SPINDLE HOLE	MEAS.	QTY/CTN	G.WT
	(mm)	(mm)	MATERIAL	MATERIAL	MATERIAL	side length	(PCS)	(KGS)
900AF	/	45	zinc	/	/	53x22x22	60	27

### N7010BK



\*open type

货号	中心距	边距	方舌	斜舌	方孔	外箱尺寸	数量/箱	毛重/箱	
	CENTRE	BACK SIDE	DEAD BOLT	LATCH	SPINDLE HOLE	MEAS.	QTY/CTN	G.WT	
	(mm)	(mm)	MATERIAL	MATERIAL	MATERIAL	side length	(PCS)	(KGS)	
N7010BK	71.8	40.5	iron/brass	zinc/brass	zinc	8x8	49X27X17	30	19





# ORIENT LOCKS

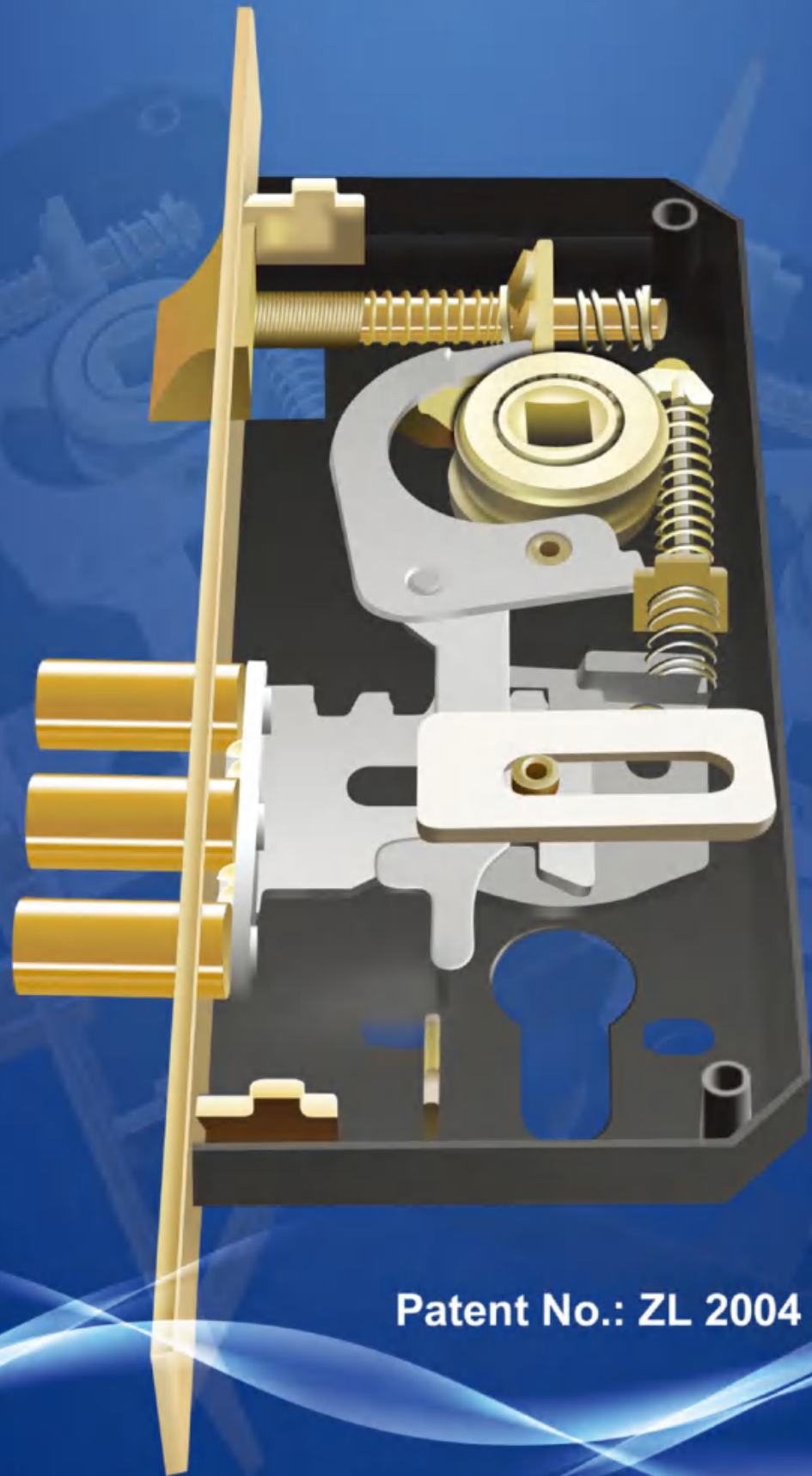

Patent No.: ZL 2004 3 0054387.6

## Lock body ORIENT LOCKS

S001

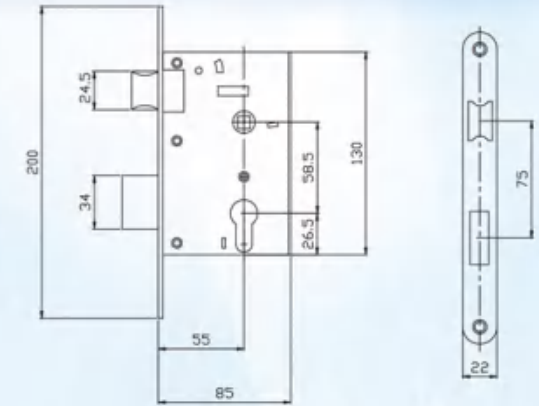
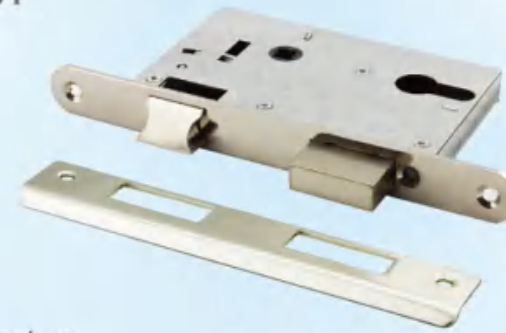

\*close type

货号	中心距	边距	方舌	斜舌	方 孔	外箱尺寸	数量/箱	毛重/箱	
	CENTRE	BACK SIDE	DEAD BOLT	LATCH	SPINDLE HOLE	MEAS.	QTY/CTN	G.WT	
	(mm)	(mm)	MATERIAL	MATERIAL	MATERIAL	side length	(PCS)	(KGS)	
S001	58.5	55	iron	zinc	iron powder	8x8	42x30x14	30	20.5

S005

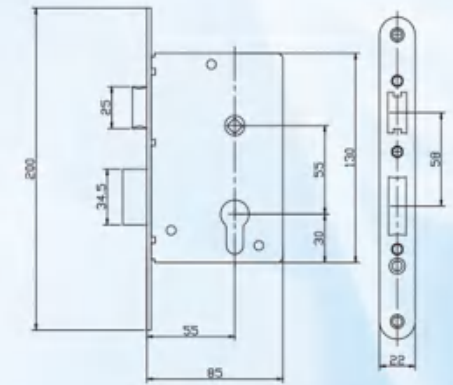

\*close type

货号	中心距	边距	方舌	斜舌	方 孔	外箱尺寸	数量/箱	毛重/箱	
	CENTRE	BACK SIDE	DEAD BOLT	LATCH	SPINDLE HOLE	MEAS.	QTY/CTN	G.WT	
	(mm)	(mm)	MATERIAL	MATERIAL	MATERIAL	side length	(PCS)	(KGS)	
S005	55	55	zinc	zinc	zinc	8x8	42x30x14	30	19.5

AL720

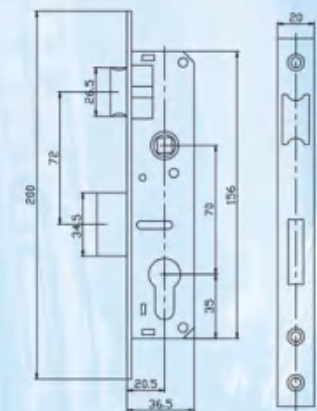

\*open type

货号	中心距	边距	方舌	斜舌	方 孔	外箱尺寸	数量/箱	毛重/箱	
	CENTRE	BACK SIDE	DEAD BOLT	LATCH	SPINDLE HOLE	MEAS.	QTY/CTN	G.WT	
	(mm)	(mm)	MATERIAL	MATERIAL	MATERIAL	side length	(PCS)	(KGS)	
AL720	70	20.5	zinc	zinc	zinc	8x8	29x26x17	30	10.5



## AL720R

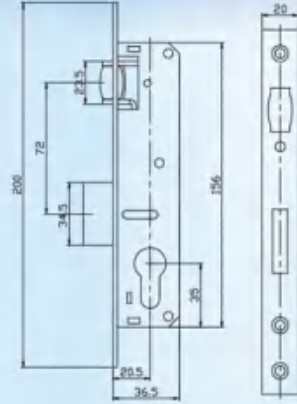

\*open type

货号	中心距	边距	方舌	滚珠	方孔	外箱尺寸	数量/箱	毛重/箱
	CENTRE	BACK SIDE	DEAD BOLT	ROLLER	SPINDLE HOLE	MEAS.	QTY/CTN	G.WT
	(mm)	(mm)	MATERIAL	MATERIAL	MATERIAL	side length (CM)	(PCS)	(KGS)
AL720R	/	20.5	zinc	brass Roller	/	29x26x17	30	10

## C720

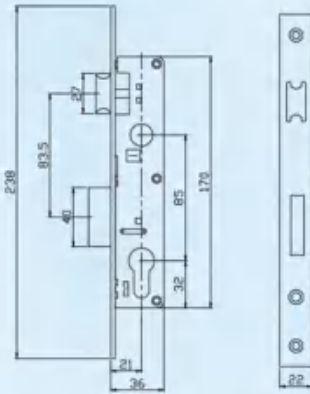

\*open type

货号	中心距	边距	方舌	斜舌	方孔	外箱尺寸	数量/箱	毛重/箱	
	CENTRE	BACK SIDE	DEAD BOLT	LATCH	SPINDLE HOLE	MEAS.	QTY/CTN	G.WT	
	(mm)	(mm)	MATERIAL	MATERIAL	MATERIAL	side length (CM)	(PCS)	(KGS)	
C720	85	21	zinc	brass	zinc	8x8	39x26.5x14	30	13

## Z65B Z75B Z95B

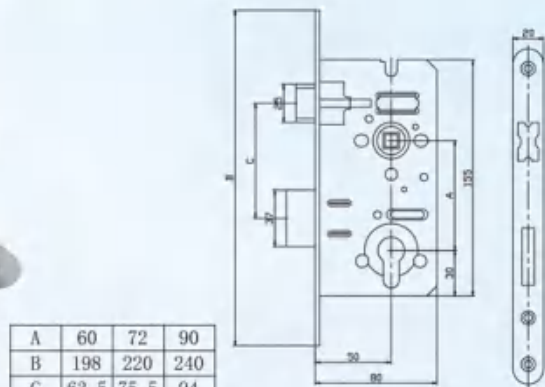

\*close type

货号	中心距	边距	方舌	斜舌	方孔	外箱尺寸	数量/箱	毛重/箱	
	CENTRE	BACK SIDE	DEAD BOLT	LATCH	SPINDLE HOLE	MEAS.	QTY/CTN	G.WT	
	(mm)	(mm)	MATERIAL	MATERIAL	MATERIAL	side length (CM)	(PCS)	(KGS)	
Z65B	60	50	zinc	zinc	zinc	8x8	44x24x27	36	19.5
Z75B	72	50	zinc	zinc	zinc	8x8	44x26x27	36	20.5
Z95B	90	50	zinc	zinc	zinc	8x8	41x29x29	36	24

## Z65C Z75C

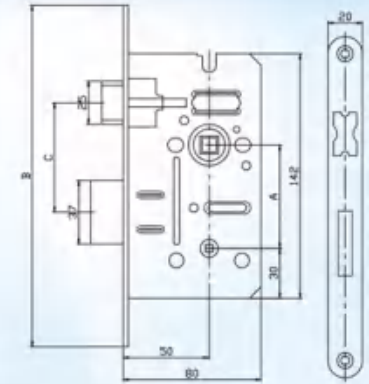

\*close type

A	60	72
B	198	220
C	63.5	75.5

货号	中心距	边距	方舌	斜舌	方孔	外箱尺寸	数量/箱	毛重/箱	
	CENTRE	BACK SIDE	DEAD BOLT	LATCH	SPINDLE HOLE	MEAS.	QTY/CTN	G.WT	
	(mm)	(mm)	MATERIAL	MATERIAL	MATERIAL	side length (CM)	(PCS)	(KGS)	
Z65C	60	50	zinc	zinc	zinc	8x8	44x24x27	36	19
Z75C	72	50	zinc	zinc	zinc	8x8	44x26x27	36	20.5

## Z65Z Z75Z Z95Z

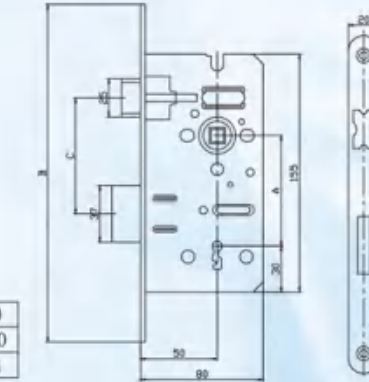

\*close type

A	60	72	90
B	198	220	240
C	63.5	75.5	94

货号	中心距	边距	方舌	斜舌	方孔	外箱尺寸	数量/箱	毛重/箱	
	CENTRE	BACK SIDE	DEAD BOLT	LATCH	SPINDLE HOLE	MEAS.	QTY/CTN	G.WT	
	(mm)	(mm)	MATERIAL	MATERIAL	MATERIAL	side length (CM)	(PCS)	(KGS)	
Z65Z	60	50	zinc	zinc	zinc	8x8	44x24x27	36	20
Z75Z	72	50	zinc	zinc	zinc	8x8	44x26x19	24	14
Z95Z	90	50	zinc	zinc	zinc	8x8	44x28x19	24	16.5

## ZT75B

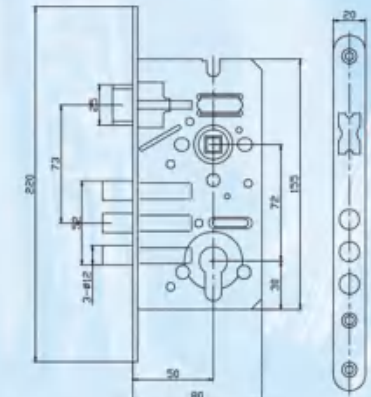
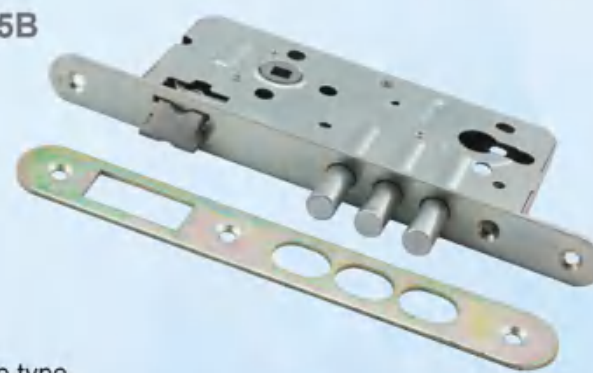

\*close type

货号	中心距	边距	方舌	斜舌	方孔	外箱尺寸	数量/箱	毛重/箱	
	CENTRE	BACK SIDE	DEAD BOLT	LATCH	SPINDLE HOLE	MEAS.	QTY/CTN	G.WT	
	(mm)	(mm)	MATERIAL	MATERIAL	MATERIAL	side length (CM)	(PCS)	(KGS)	
ZT75B	72	50	3 ROD	zinc	zinc	8x8	44x26x19	24	15



## ZT95B

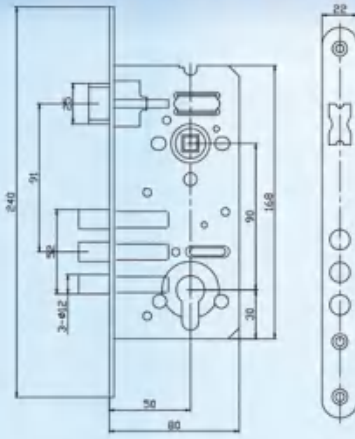
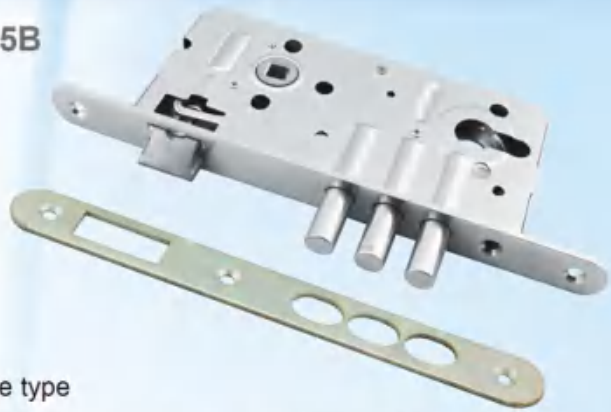

\*close type

货号	中心距	边距	方舌	斜舌	方孔	外箱尺寸	数量/箱	毛重/箱	
	CENTRE	BACK SIDE	DEAD BOLT	LATCH	SPINDLE HOLE	MEAS.	QTY/CTN	G.WT	
	(mm)	(mm)	MATERIAL	MATERIAL	MATERIAL	side length (CM)	(PCS)	(KGS)	
ZT95B	90	50	3 ROD	zinc	zinc	8x8	43X29X20	24	16

## Z200

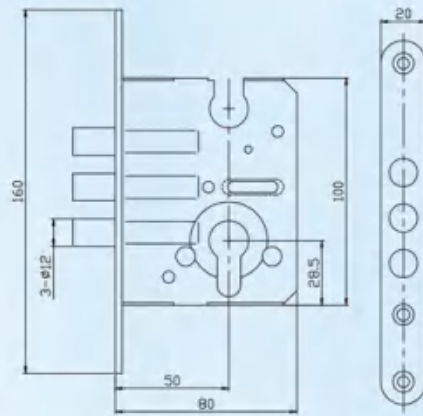

\*close type

货号	中心距	边距	方舌	斜舌	方孔	外箱尺寸	数量/箱	毛重/箱	
	CENTRE	BACK SIDE	DEAD BOLT	LATCH	SPINDLE HOLE	MEAS.	QTY/CTN	G.WT	
	(mm)	(mm)	MATERIAL	MATERIAL	MATERIAL	side length (CM)	(PCS)	(KGS)	
Z200	/	50	3 ROD	/	/	/	43X30X14	30	13

## Z925B Z930B Z935B

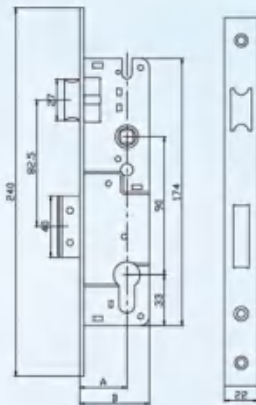

\*open type

A	25	30	35
B	40	45	50

货号	中心距	边距	方舌	斜舌	方孔	外箱尺寸	数量/箱	毛重/箱	
	CENTRE	BACK SIDE	DEAD BOLT	LATCH	SPINDLE HOLE	MEAS.	QTY/CTN	G.WT	
	(mm)	(mm)	MATERIAL	MATERIAL	MATERIAL	side length (CM)	(PCS)	(KGS)	
Z925B	90	25	zinc	brass	zinc	8x8	30x19x28	30	16
Z930B	90	30	zinc	brass	zinc	8x8	30x19x28	30	16.5
Z935B	90	35	zinc	brass	zinc	8x8	30x19x28	30	17

## 032-40

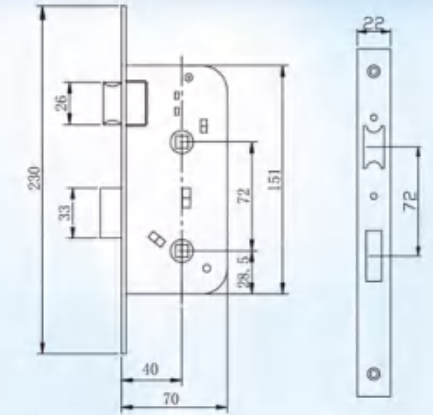

\*close type

货号	中心距	边距	方舌	斜舌	方孔	外箱尺寸	数量/箱	毛重/箱	
	CENTRE	BACK SIDE	DEAD BOLT	LATCH	SPINDLE HOLE	MEAS.	QTY/CTN	G.WT	
	(mm)	(mm)	MATERIAL	MATERIAL	MATERIAL	side length (CM)	(PCS)	(KGS)	
032-40	72	40	brass	brass	brass	8x8,8x8	53x27x14	30	20

## 032-40K

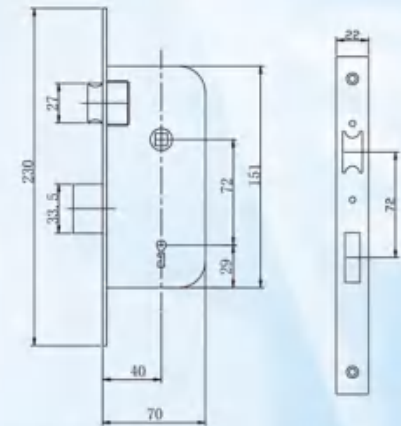

\*close type

货号	中心距	边距	方舌	斜舌	方孔	外箱尺寸	数量/箱	毛重/箱	
	CENTRE	BACK SIDE	DEAD BOLT	LATCH	SPINDLE HOLE	MEAS.	QTY/CTN	G.WT	
	(mm)	(mm)	MATERIAL	MATERIAL	MATERIAL	side length (CM)	(PCS)	(KGS)	
032-40K	72	40	brass	brass	brass	8x8	53x27x14	30	20.5

## 032-40C

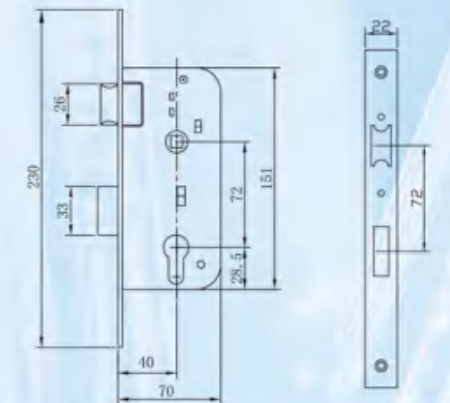
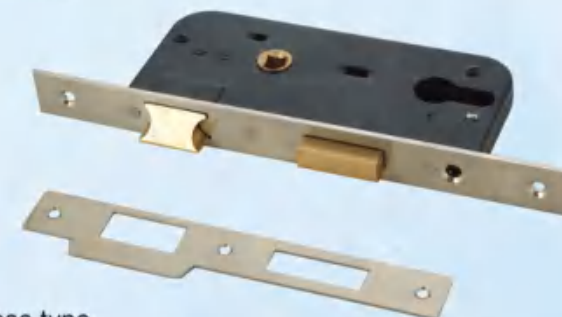

\*close type

货号	中心距	边距	方舌	斜舌	方孔	外箱尺寸	数量/箱	毛重/箱	
	CENTRE	BACK SIDE	DEAD BOLT	LATCH	SPINDLE HOLE	MEAS.	QTY/CTN	G.WT	
	(mm)	(mm)	MATERIAL	MATERIAL	MATERIAL	side length (CM)	(PCS)	(KGS)	
032-40C	72	40	brass	brass	brass	8x8	53x27x14	30	19.5



100

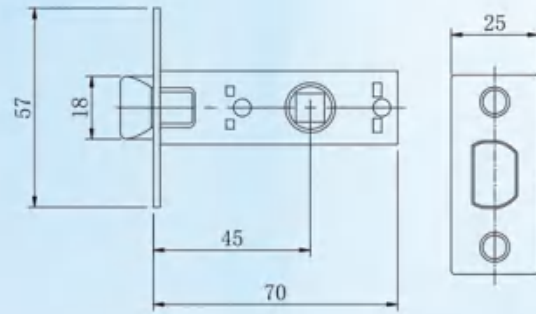

\*close type

货号	中心距	边距	方舌	斜舌	方 孔	外箱尺寸	数量/箱	毛重/箱	
	CENTRE	BACK SIDE	DEAD BOLT	LATCH	SPINDLE HOLE	MEAS.	QTY/CTN	G.WT	
	(mm)	(mm)	MATERIAL	MATERIAL	MATERIAL	side length	(PCS)	(KGS)	
100	/	45	zinc	/	zinc	8x8	51x43x17	200	23

101

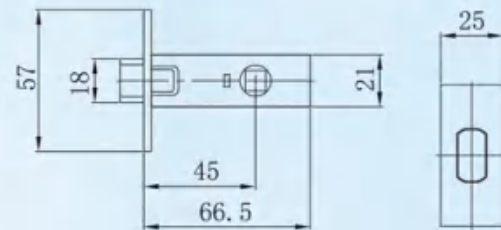

\*close type

货号	中心距	边距	方舌	斜舌	方 孔	外箱尺寸	数量/箱	毛重/箱	
	CENTRE	BACK SIDE	DEAD BOLT	LATCH	SPINDLE HOLE	MEAS.	QTY/CTN	G.WT	
	(mm)	(mm)	MATERIAL	MATERIAL	MATERIAL	side length	(PCS)	(KGS)	
101	/	45	zinc	/	zinc	6x6	51x43x17	200	22

1050

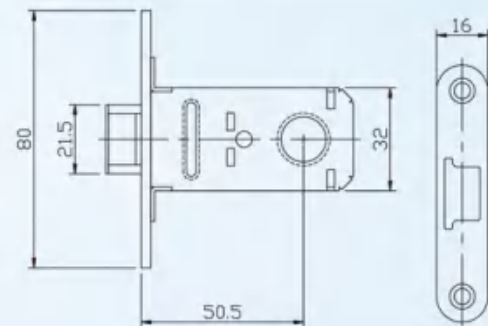

\*close type

货号	中心距	边距	方舌	斜舌	方 孔	外箱尺寸	数量/箱	毛重/箱	
	CENTRE	BACK SIDE	DEAD BOLT	LATCH	SPINDLE HOLE	MEAS.	QTY/CTN	G.WT	
	(mm)	(mm)	MATERIAL	MATERIAL	MATERIAL	side length	(PCS)	(KGS)	
1050	/	50.5	zinc	/	zinc	8x8	51x43x17	100	15

DF-35 (510.35R)

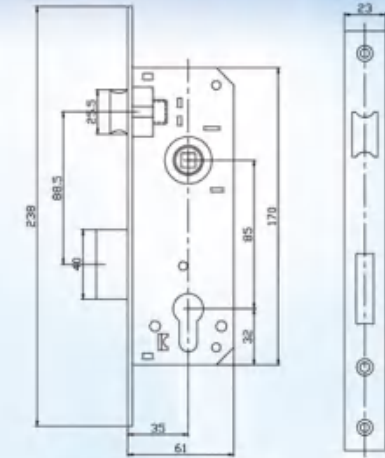

\*close type

货号	中心距	边距	方舌	斜舌	方 孔	外箱尺寸	数量/箱	毛重/箱	
	CENTRE	BACK SIDE	DEAD BOLT	LATCH	SPINDLE HOLE	MEAS.	QTY/CTN	G.WT	
	(mm)	(mm)	MATERIAL	MATERIAL	MATERIAL	side length	(PCS)	(KGS)	
DF-35	85	35	iron/brass	zinc/brass	zinc	8x8	49x27x17	30	21

DF-45B

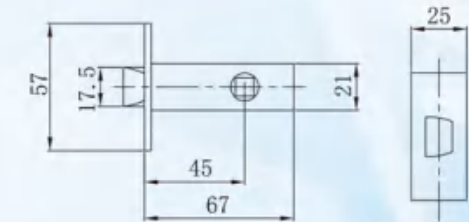

\*close type

货号	中心距	边距	方舌	斜舌	方 孔	外箱尺寸	数量/箱	毛重/箱	
	CENTRE	BACK SIDE	DEAD BOLT	LATCH	SPINDLE HOLE	MEAS.	QTY/CTN	G.WT	
	(mm)	(mm)	MATERIAL	MATERIAL	MATERIAL	side length	(PCS)	(KGS)	
DF-45B	/	45	zinc	/	zinc	8x8	35x33x32	200	22

110R

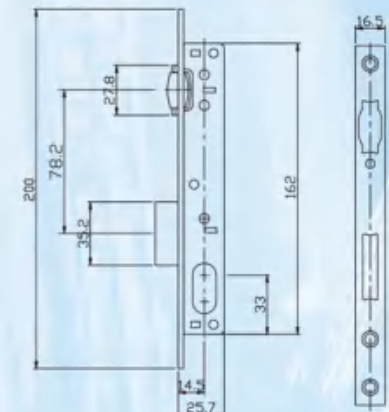

\*open type

货号	中心距	边距	方舌	滚珠	方 孔	外箱尺寸	数量/箱	毛重/箱	
	CENTRE	BACK SIDE	DEAD BOLT	ROLLER	SPINDLE HOLE	MEAS.	QTY/CTN	G.WT	
	(mm)	(mm)	MATERIAL	MATERIAL	MATERIAL	side length	(PCS)	(KGS)	
110R	/	14.5	brass	brass Roller	/	/	28x26.5x17	30	13.5



111

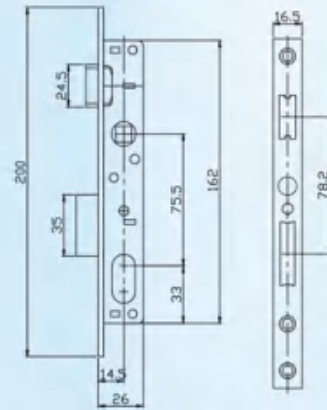

\*open type

货号	中心距	边距	方舌	斜舌	方 孔	外箱尺寸	数量/箱	毛重/箱	
	CENTRE	BACK SIDE	DEAD BOLT	LATCH	SPINDLE HOLE	MEAS.	QTY/CTN	G.WT	
	(mm)	(mm)	MATERIAL	MATERIAL	MATERIAL	side length	(PCS)	(KGS)	
111	75.5	14.5	brass	brass	iron powder	8x8	28x26.5x17	30	13.5

1216

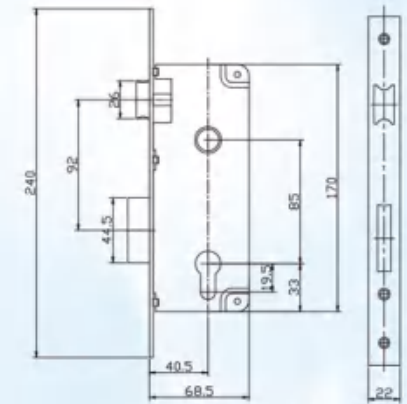
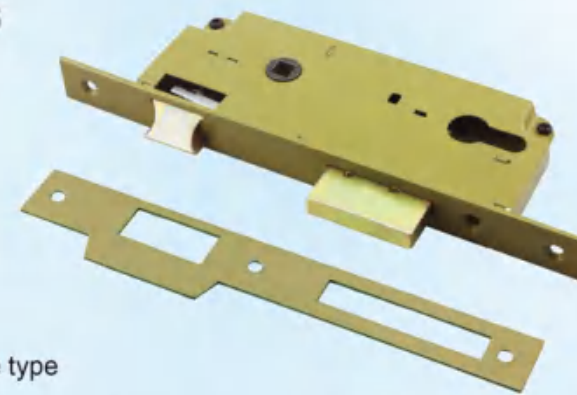

\*close type

货号	中心距	边距	方舌	斜舌	方 孔	外箱尺寸	数量/箱	毛重/箱	
	CENTRE	BACK SIDE	DEAD BOLT	LATCH	SPINDLE HOLE	MEAS.	QTY/CTN	G.WT	
	(mm)	(mm)	MATERIAL	MATERIAL	MATERIAL	side length	(PCS)	(KGS)	
1216	85	40.5	iron/brass	zinc/brass	iron powder	8x8 7x7	49x27x17	30	19

112

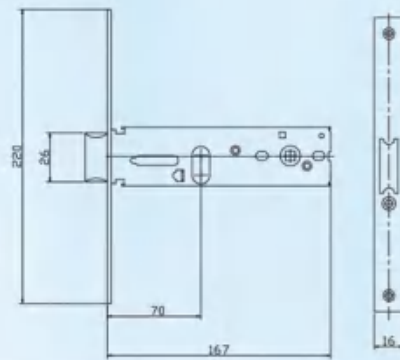

\*close type

货号	中心距	边距	方舌	斜舌	方 孔	外箱尺寸	数量/箱	毛重/箱	
	CENTRE	BACK SIDE	DEAD BOLT	LATCH	SPINDLE HOLE	MEAS.	QTY/CTN	G.WT	
	(mm)	(mm)	MATERIAL	MATERIAL	MATERIAL	side length	(PCS)	(KGS)	
112	67	70	/	brass	iron powder	8x8	39x38.5x18	30	14

130

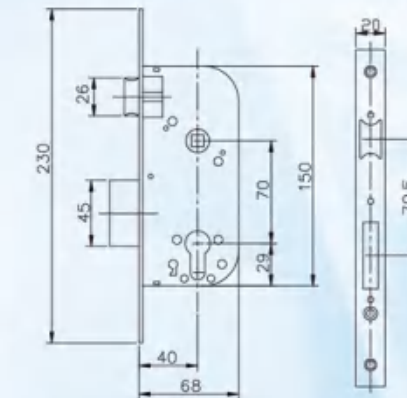
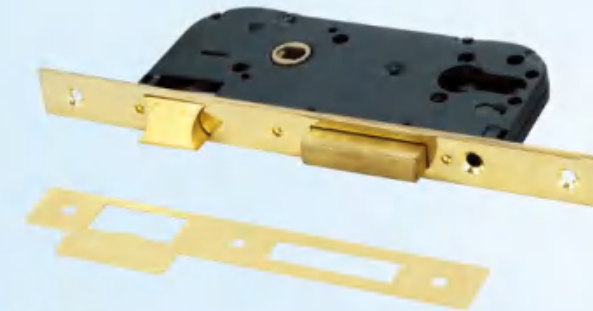

\*close type

货号	中心距	边距	方舌	斜舌	方 孔	外箱尺寸	数量/箱	毛重/箱	
	CENTRE	BACK SIDE	DEAD BOLT	LATCH	SPINDLE HOLE	MEAS.	QTY/CTN	G.WT	
	(mm)	(mm)	MATERIAL	MATERIAL	MATERIAL	side length	(PCS)	(KGS)	
130	70	40	iron/brass	zinc/brass	zinc	8x8	53x27x14	30	16

114

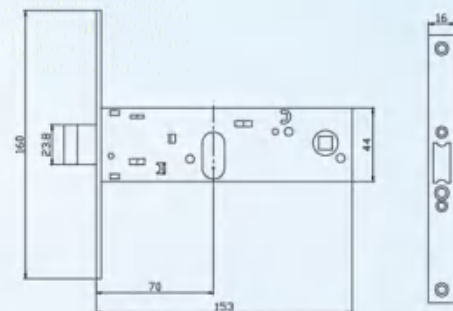

\*close type

货号	中心距	边距	方舌	斜舌	方 孔	外箱尺寸	数量/箱	毛重/箱	
	CENTRE	BACK SIDE	DEAD BOLT	LATCH	SPINDLE HOLE	MEAS.	QTY/CTN	G.WT	
	(mm)	(mm)	MATERIAL	MATERIAL	MATERIAL	side length	(PCS)	(KGS)	
114	67	70	/	zinc	iron powder	8x8	39x38.5x18	30	11

135-25

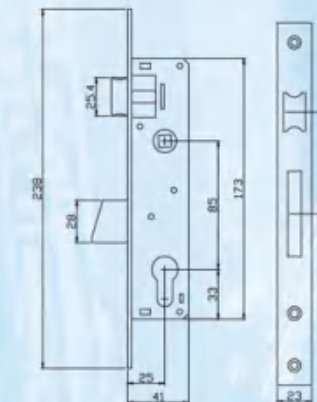

\*open type

货号	中心距	边距	方舌	斜舌	方 孔	外箱尺寸	数量/箱	毛重/箱	
	CENTRE	BACK SIDE	DEAD BOLT	LATCH	SPINDLE HOLE	MEAS.	QTY/CTN	G.WT	
	(mm)	(mm)	MATERIAL	MATERIAL	MATERIAL	side length	(PCS)	(KGS)	
135-25	85	25	zinc hook	zinc	iron powder	8x8	41x26x14	30	14



## 135-25R

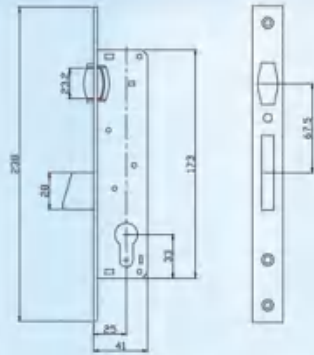

\*open type

货号	中心距	边距	方舌	滚珠	方孔	外箱尺寸	数量/箱	毛重/箱
	CENTRE	BACK SIDE	DEAD BOLT	ROLLER	SPINDLE HOLE	MEAS.	QTY/CTN	G.WT
	(mm)	(mm)	MATERIAL	MATERIAL	MATERIAL	side length (CM)	(PCS)	(KGS)
135-25R	/	25	zinc hook	brass Roller	/	41x26x14	30	14.5

## 153-20BB 153-25BB 153-30BB 153-35BB

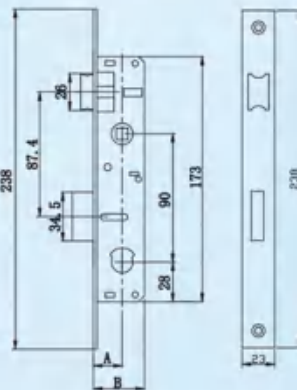
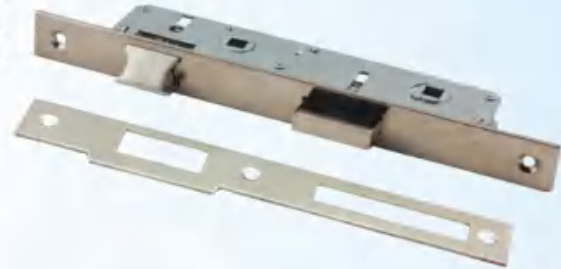

\*open type

A	20	25	30	35
B	36	41	46	51

货号	中心距	边距	方舌	斜舌	方孔	外箱尺寸	数量/箱	毛重/箱	
	CENTRE	BACK SIDE	DEAD BOLT	LATCH	SPINDLE HOLE	MEAS.	QTY/CTN	G.WT	
	(mm)	(mm)	MATERIAL	MATERIAL	MATERIAL	side length (CM)	(PCS)	(KGS)	
153-20BB	90	20	zinc	zinc/brass	zinc	8x8 8x8	41x26x17	30	14
153-25BB	90	25	zinc	zinc/brass	zinc	8x8 8x8	41x26x17	30	15
153-30BB	90	30	zinc	zinc/brass	zinc	8x8 8x8	41x26x17	30	16
153-35BB	90	35	zinc	zinc/brass	zinc	8x8 8x8	41x26x17	30	17

## 153-20(20X85) 153-25(25X85) 153-30(30X85) 153-35(35X85)

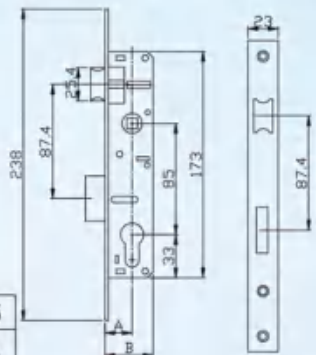

\*open type

A	20	25	30	35
B	36	40	46	51

货号	中心距	边距	方舌	斜舌	方孔	外箱尺寸	数量/箱	毛重/箱	
	CENTRE	BACK SIDE	DEAD BOLT	LATCH	SPINDLE HOLE	MEAS.	QTY/CTN	G.WT	
	(mm)	(mm)	MATERIAL	MATERIAL	MATERIAL	side length (CM)	(PCS)	(KGS)	
153-20	85	20	zinc	zinc/brass	zinc	8x8	41x26x17	30	14
153-25	85	25	zinc	zinc/brass	zinc	8x8	41x26x17	30	14.5
153-30	85	30	zinc	zinc/brass	zinc	8x8	41x26x17	30	15
153-35	85	35	zinc	zinc/brass	zinc	8x8	41x26x17	30	16

## 155-20BB 155-25BB 155-30BB 155-35BB

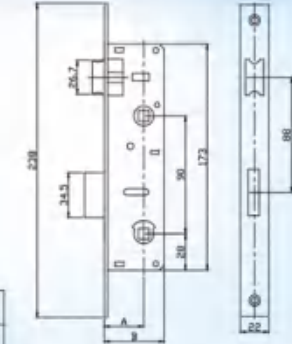

\*open type

A	20	25	30	35
B	36	41	46	51

货号	中心距	边距	方舌	斜舌	方孔	外箱尺寸	数量/箱	毛重/箱	
	CENTRE	BACK SIDE	DEAD BOLT	LATCH	SPINDLE HOLE	MEAS.	QTY/CTN	G.WT	
	(mm)	(mm)	MATERIAL	MATERIAL	MATERIAL	side length (CM)	(PCS)	(KGS)	
155-20BB	90	20	zinc	zinc/brass	zinc	8x8	41x26x17	30	14.5
155-25BB	90	25	zinc	zinc/brass	zinc	8x8	41x26x17	30	15
155-30BB	90	30	zinc	zinc/brass	zinc	8x8	41x26x17	30	15.5
155-35BB	90	35	zinc	zinc/brass	zinc	8x8	41x26x17	30	16

## 155-30BB

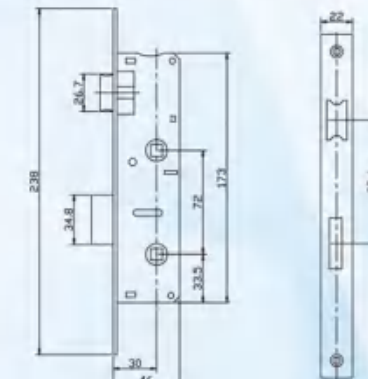

\*open type

货号	中心距	边距	方舌	斜舌	方孔	外箱尺寸	数量/箱	毛重/箱	
	CENTRE	BACK SIDE	DEAD BOLT	LATCH	SPINDLE HOLE	MEAS.	QTY/CTN	G.WT	
	(mm)	(mm)	MATERIAL	MATERIAL	MATERIAL	side length (CM)	(PCS)	(KGS)	
155-30BB	72	30	zinc	zinc/brass	zinc	8x8, 8x8	38x27x24	30	16

## 153-20R 153-25R 153-30R 153-35R

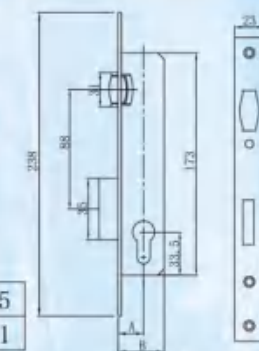

\*open type

A	20	25	30	35
B	36	40	46	51

货号	中心距	边距	方舌	滚珠	方孔	外箱尺寸	数量/箱	毛重/箱
	CENTRE	BACK SIDE	DEAD BOLT	ROLLER	SPINDLE HOLE	MEAS.	QTY/CTN	G.WT
	(mm)	(mm)	MATERIAL	MATERIAL	MATERIAL	side length (CM)	(PCS)	(KGS)
153-20R	/	20	zinc	brass Roller	/	38x27x14	30	13.5
153-25R	/	25	zinc	brass Roller	/	38x27x14	30	14
153-30R	/	30	zinc	brass Roller	/	38x27x14	30	14.5
153-35R	/	35	zinc	brass Roller	/	42x26x14	30	15



155-20  
155-25  
155-30  
155-35



A	20	25	30	35
B	36	41	46	51

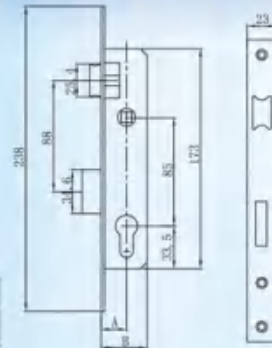

\*open type

货号	中心距	边距	方舌	斜舌	方孔	外箱尺寸	数量/箱	毛重/箱	
	CENTRE	BACK SIDE	DEAD BOLT	LATCH	SPINDLE HOLE	MEAS.	QTY/CTN	G.WT	
	(mm)	(mm)	MATERIAL	MATERIAL	MATERIAL	side length (CM)	(PCS)	(KGS)	
155-20	85	20	zinc	zinc/brass	zinc	8x8	38x27x24	30	13.5
155-25	85	25	zinc	zinc/brass	zinc	8x8	38x27x24	30	14.5
155-30	85	30	zinc	zinc/brass	zinc	8x8	38x27x24	30	15
155-35	85	35	zinc	zinc/brass	zinc	8x8	38x27x24	30	16

155-20R  
155-25R  
155-30R  
155-35R



A	20	25	30	35
B	36	41	46	51

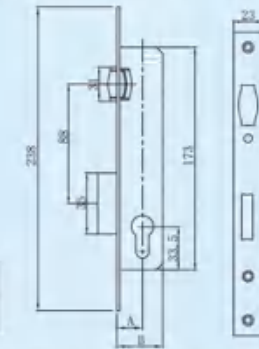

\*open type

货号	中心距	边距	方舌	滚珠	方孔	外箱尺寸	数量/箱	毛重/箱	
	CENTRE	BACK SIDE	DEAD BOLT	ROLLER	SPINDLE HOLE	MEAS.	QTY/CTN	G.WT	
	(mm)	(mm)	MATERIAL	MATERIAL	MATERIAL	side length (CM)	(PCS)	(KGS)	
155-20R	/	20	zinc	brass Roller	/	/	38x27x24	30	13.5
155-25R	/	25	zinc	brass Roller	/	/	38x27x24	30	14.5
155-30R	/	30	zinc	brass Roller	/	/	38x27x24	30	15.5
155-35R	/	35	zinc	brass Roller	/	/	38x27x24	30	16.5

165-20BB  
165-25BB  
165-35BB

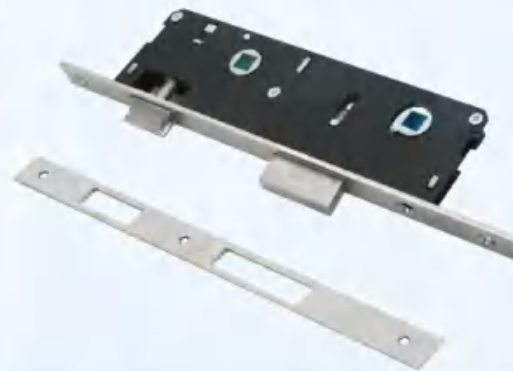

A	20	25	35
B	36	41	51

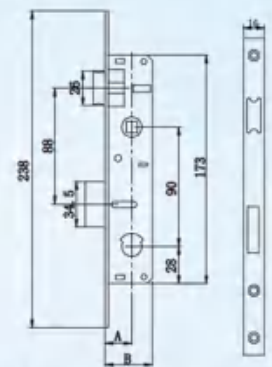

\*open type

货号	中心距	边距	方舌	斜舌	方孔	外箱尺寸	数量/箱	毛重/箱	
	CENTRE	BACK SIDE	DEAD BOLT	LATCH	SPINDLE HOLE	MEAS.	QTY/CTN	G.WT	
	(mm)	(mm)	MATERIAL	MATERIAL	MATERIAL	side length (CM)	(PCS)	(KGS)	
165-20BB	90	20	zinc	zinc	zinc	8x8, 8x8	41x26x17	30	13
165-25BB	90	25	zinc	zinc	zinc	8x8, 8x8	41x26x17	30	14
165-35BB	90	35	zinc	zinc	zinc	8x8, 8x8	41x26x17	30	16

163-20  
163-25  
163-30  
163-35



A	20	25	30	35
B	36	40	46	51

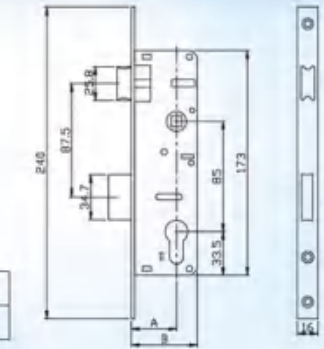

\*open type

货号	中心距	边距	方舌	斜舌	方孔	外箱尺寸	数量/箱	毛重/箱	
	CENTRE	BACK SIDE	DEAD BOLT	LATCH	SPINDLE HOLE	MEAS.	QTY/CTN	G.WT	
	(mm)	(mm)	MATERIAL	MATERIAL	MATERIAL	side length (CM)	(PCS)	(KGS)	
163-20	85	20	zinc	zinc	zinc	8x8	38x27x14	30	12.5
163-25	85	25	zinc	zinc	zinc	8x8	38x27x14	30	13
163-30	85	30	zinc	zinc	zinc	8x8	38x27x14	30	13.5
163-35	85	35	zinc	zinc	zinc	8x8	38x27x14	30	14

163-20R  
163-25R  
163-30R  
163-35R



A	20	25	30	35
B	36	40	46	51

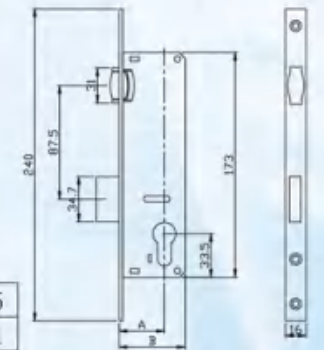

\*open type

货号	中心距	边距	方舌	斜舌	方孔	外箱尺寸	数量/箱	毛重/箱	
	CENTRE	BACK SIDE	DEAD BOLT	LATCH	SPINDLE HOLE	MEAS.	QTY/CTN	G.WT	
	(mm)	(mm)	MATERIAL	MATERIAL	MATERIAL	side length (CM)	(PCS)	(KGS)	
163-20R	/	20	zinc	brass Roller	/	/	38x27x14	30	12.5
163-25R	/	25	zinc	brass Roller	/	/	38x27x14	30	13
163-30R	/	30	zinc	brass Roller	/	/	38x27x14	30	13.5
163-35R	/	35	zinc	brass Roller	/	/	38x27x14	30	14

165-20  
165-25  
165-30  
165-35

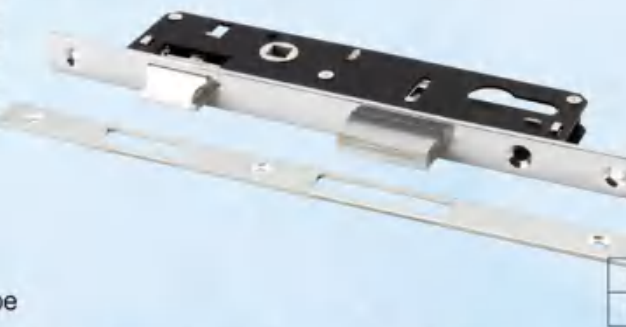

A	20	25	30	35
B	36.5	41.5	46.5	51.5

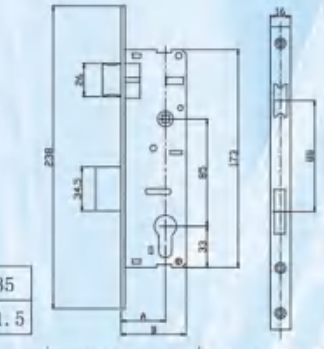

\*open type

货号	中心距	边距	方舌	斜舌	方孔	外箱尺寸	数量/箱	毛重/箱	
	CENTRE	BACK SIDE	DEAD BOLT	LATCH	SPINDLE HOLE	MEAS.	QTY/CTN	G.WT	
	(mm)	(mm)	MATERIAL	MATERIAL	MATERIAL	side length (CM)	(PCS)	(KGS)	
165-20	85	20	zinc	zinc	zinc	8x8	38x27x14	30	13
165-25	85	25	zinc	zinc	zinc	8x8	38x27x14	30	13.5
165-30	85	30	zinc	zinc	zinc	8x8	38x27x14	30	14
165-35	85	35	zinc	zinc	zinc	8x8	38x27x14	30	15



165-20R  
165-25R  
165-30R  
165-35R



A	20	25	30	35
B	36	41	46	51

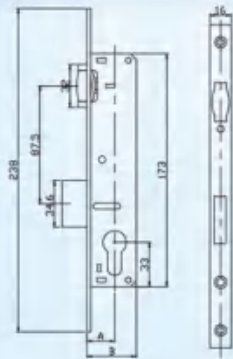

\*open type

货号	中心距	边距	方舌	滚珠	方孔	外箱尺寸	数量/箱	毛重/箱	
	CENTRE	BACK SIDE	DEAD BOLT	ROLLER	SPINDLE HOLE	MEAS.	QTY/CTN	G.WT	
	(mm)	(mm)	MATERIAL	MATERIAL	MATERIAL	side length (CM)	(PCS)	(KGS)	
165-20R	/	20	zinc	brass Roller	/	/	38x27x14	30	12.5
165-25R	/	25	zinc	brass Roller	/	/	38x27x14	30	13
165-30R	/	30	zinc	brass Roller	/	/	38x27x14	30	14.5
165-35R	/	35	zinc	brass Roller	/	/	38x27x14	30	15

189-3M

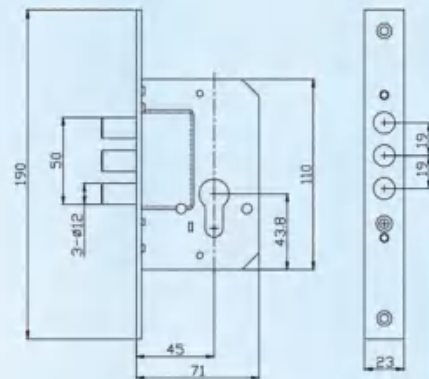

\*half close type

货号	中心距	边距	方舌	斜舌	方孔	外箱尺寸	数量/箱	毛重/箱	
	CENTRE	BACK SIDE	DEAD BOLT	LATCH	SPINDLE HOLE	MEAS.	QTY/CTN	G.WT	
	(mm)	(mm)	MATERIAL	MATERIAL	MATERIAL	side length (CM)	(PCS)	(KGS)	
189-3M	/	45	3 ROD	/	/	/	43x29x14	30	15

189-F

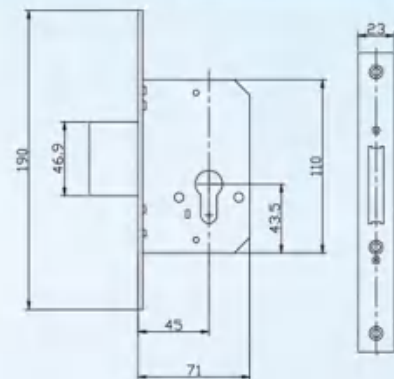

\*half close type

货号	中心距	边距	方舌	斜舌	方孔	外箱尺寸	数量/箱	毛重/箱	
	CENTRE	BACK SIDE	DEAD BOLT	LATCH	SPINDLE HOLE	MEAS.	QTY/CTN	G.WT	
	(mm)	(mm)	MATERIAL	MATERIAL	MATERIAL	side length (CM)	(PCS)	(KGS)	
189F	/	45	brass	/	/	/	43x30x14	30	15

189-4A

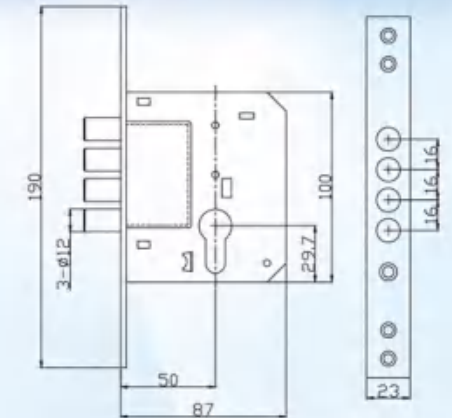

\*close type

货号	中心距	边距	方舌	斜舌	方孔	外箱尺寸	数量/箱	毛重/箱	
	CENTRE	BACK SIDE	DEAD BOLT	LATCH	SPINDLE HOLE	MEAS.	QTY/CTN	G.WT	
	(mm)	(mm)	MATERIAL	MATERIAL	MATERIAL	side length (CM)	(PCS)	(KGS)	
189-4A	/	50	4 ROD	/	/	/	51x22x16.5	30	15

194-40R  
194-45R  
194-50R  
194-60R

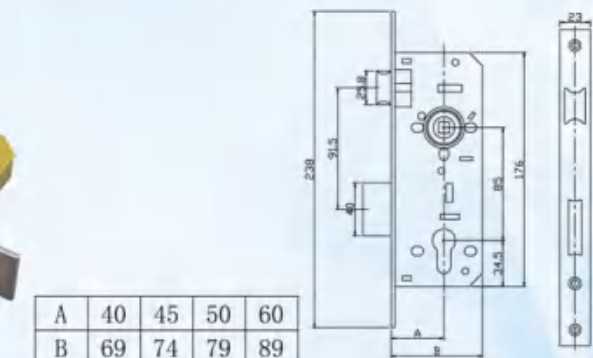
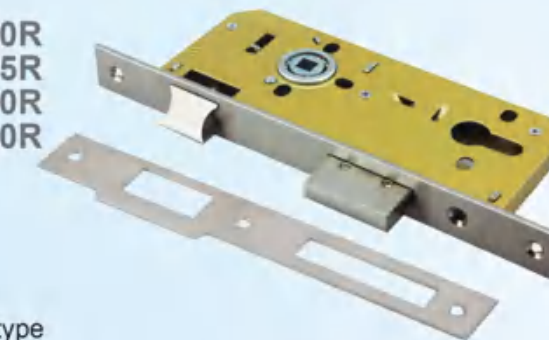

\*close type

货号	中心距	边距	方舌	斜舌	方孔	外箱尺寸	数量/箱	毛重/箱	
	CENTRE	BACK SIDE	DEAD BOLT	LATCH	SPINDLE HOLE	MEAS.	QTY/CTN	G.WT	
	(mm)	(mm)	MATERIAL	MATERIAL	MATERIAL	side length (CM)	(PCS)	(KGS)	
194-40R	85	40	iron/brass	zinc/brass	zinc	8x8	48X26X17	30	20
194-45R	85	45	iron/brass	zinc/brass	zinc	8x8	48X26X17	30	22
194-50R	85	50	iron/brass	zinc/brass	zinc	8x8	48X26X17	30	23.5
194-60R	85	60	iron/brass	zinc/brass	zinc	8x8	55x27x17	30	25

194-45R-3R  
194-50R-3R  
194-60R-3R

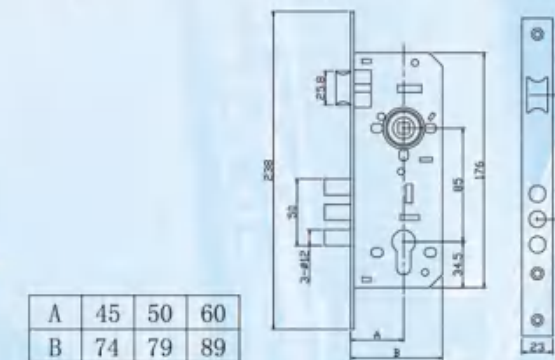

\*close type

货号	中心距	边距	方舌	斜舌	方孔	外箱尺寸	数量/箱	毛重/箱	
	CENTRE	BACK SIDE	DEAD BOLT	LATCH	SPINDLE HOLE	MEAS.	QTY/CTN	G.WT	
	(mm)	(mm)	MATERIAL	MATERIAL	MATERIAL	side length (CM)	(PCS)	(KGS)	
194-45R-3R	85	45	3ROD	zinc/brass	zinc	8x8	52X29X14	30	22
194-50R-3R	85	50	3ROD	zinc/brass	zinc	8x8	52X29X14	30	22.5
194-60R-3R	85	60	3ROD	zinc/brass	zinc	8x8	52X29X14	30	23.5



### 201-40

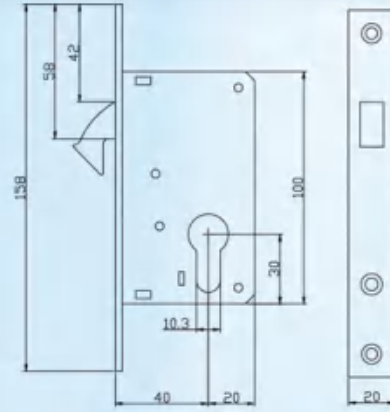

\*open type

货号	中心距	边距	方舌	斜舌	方孔	外箱尺寸	数量/箱	毛重/箱
	CENTRE	BACK SIDE	DEAD BOLT	LATCH	SPINDLE HOLE	MEAS.	QTY/CTN	G.WT
	(mm)	(mm)	MATERIAL	MATERIAL	MATERIAL	side length (CM)	(PCS)	(KGS)
201-40	/	40	brass hook	/	/	35x29x15	30	10

### 215

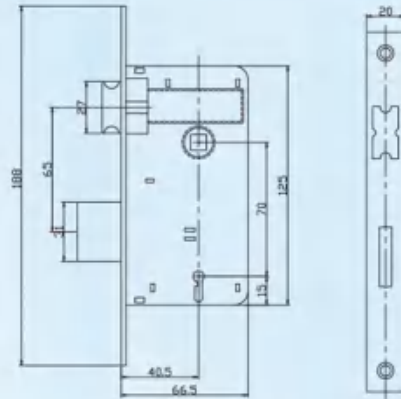

\*close type

货号	中心距	边距	方舌	斜舌	方孔	外箱尺寸	数量/箱	毛重/箱	
	CENTRE	BACK SIDE	DEAD BOLT	LATCH	SPINDLE HOLE	MEAS.	QTY/CTN	G.WT	
	(mm)	(mm)	MATERIAL	MATERIAL	MATERIAL	side length (CM)	(PCS)	(KGS)	
215	70	40.5	iron	zinc	zinc	8x8	43x30x15	40	14

### 20BB

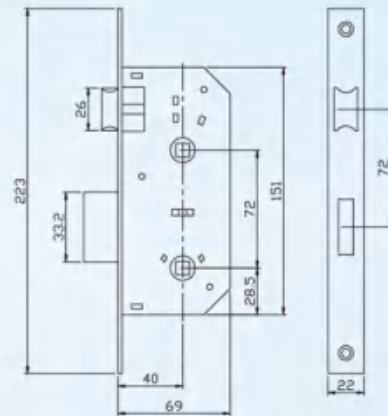
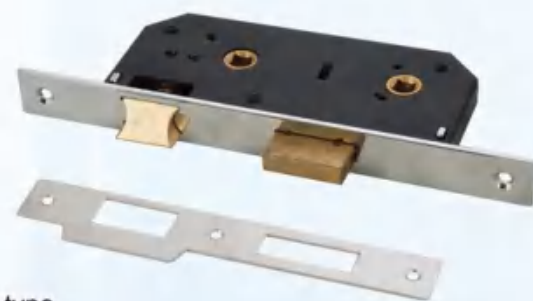

\*close type

货号	中心距	边距	方舌	斜舌	方孔	外箱尺寸	数量/箱	毛重/箱	
	CENTRE	BACK SIDE	DEAD BOLT	LATCH	SPINDLE HOLE	MEAS.	QTY/CTN	G.WT	
	(mm)	(mm)	MATERIAL	MATERIAL	MATERIAL	side length (CM)	(PCS)	(KGS)	
20BB	72	40	iron	iron	brass	8x8, 8x8	42x28x14	30	19

### 30CK

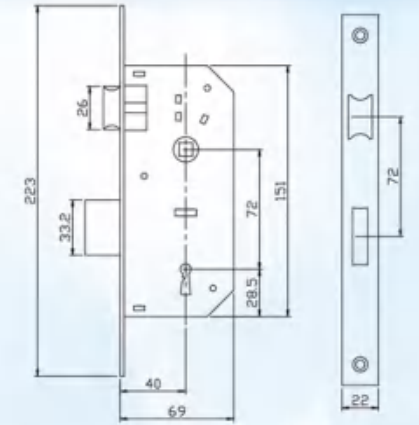

\*close type

货号	中心距	边距	方舌	斜舌	方孔	外箱尺寸	数量/箱	毛重/箱	
	CENTRE	BACK SIDE	DEAD BOLT	LATCH	SPINDLE HOLE	MEAS.	QTY/CTN	G.WT	
	(mm)	(mm)	MATERIAL	MATERIAL	MATERIAL	side length (CM)	(PCS)	(KGS)	
30CK	72	40	iron	iron	brass	8x8	42x28x14	30	20

### 2225

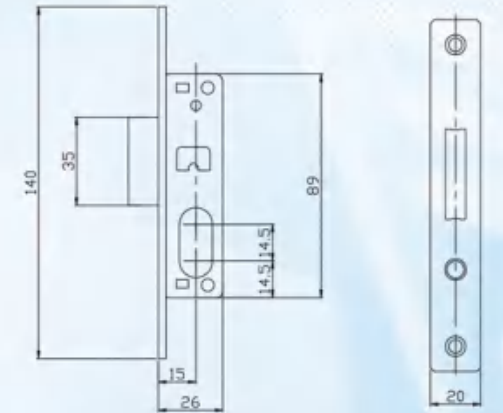

\*open type

货号	中心距	边距	方舌	斜舌	方孔	外箱尺寸	数量/箱	毛重/箱
	CENTRE	BACK SIDE	DEAD BOLT	LATCH	SPINDLE HOLE	MEAS.	QTY/CTN	G.WT
	(mm)	(mm)	MATERIAL	MATERIAL	MATERIAL	side length (CM)	(PCS)	(KGS)
2225	/	15	zinc	/	/	40x21x15	48	14

### 310-40A

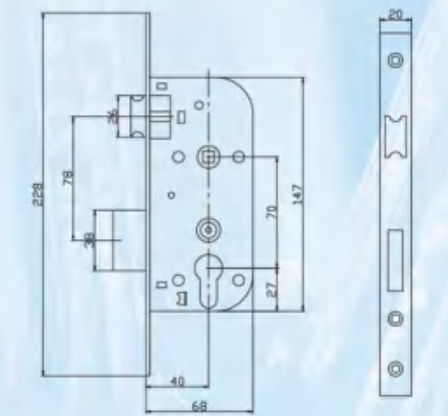

\*close type

货号	中心距	边距	方舌	斜舌	方孔	外箱尺寸	数量/箱	毛重/箱	
	CENTRE	BACK SIDE	DEAD BOLT	LATCH	SPINDLE HOLE	MEAS.	QTY/CTN	G.WT	
	(mm)	(mm)	MATERIAL	MATERIAL	MATERIAL	side length (CM)	(PCS)	(KGS)	
310-40A	70	40	iron/brass	zinc/brass	zinc	8x8	43x25x16	30	16.5



## 310-45A

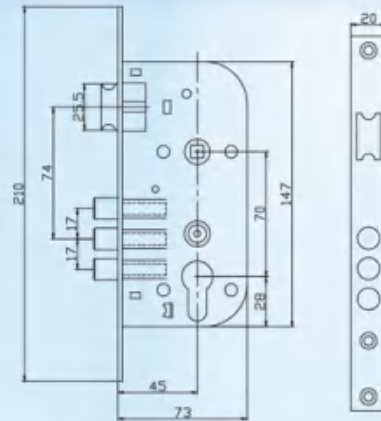

\*close type

货号	中心距	边距	方舌	斜舌	方孔	外箱尺寸	数量/箱	毛重/箱	
	CENTRE	BACK SIDE	DEAD BOLT	LATCH	SPINDLE HOLE	MEAS.	QTY/CTN	G.WT	
	(mm)	(mm)	MATERIAL	MATERIAL	MATERIAL	side length (CM)	(PCS)	(KGS)	
310-45A	70	45	3 ROD	zinc/brass	zinc	8x8	43x25x16	30	17

## 361-20R

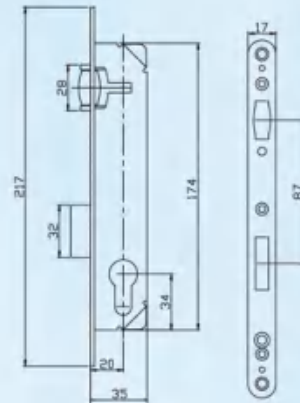

\*open type

货号	中心距	边距	方舌	滚珠	方孔	外箱尺寸	数量/箱	毛重/箱	
	CENTRE	BACK SIDE	DEAD BOLT	ROLLER	SPINDLE HOLE	MEAS.	QTY/CTN	G.WT	
	(mm)	(mm)	MATERIAL	MATERIAL	MATERIAL	side length (CM)	(PCS)	(KGS)	
361-20R	/	20	zinc	iron Roller	/	/	35x31x28	50	18

## 361-20RO

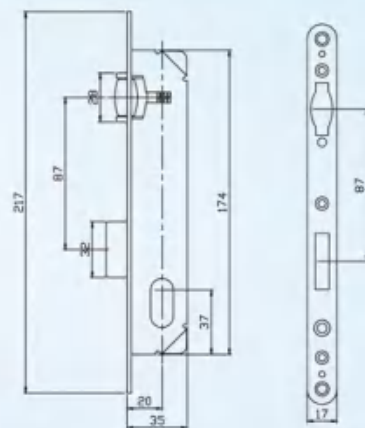

\*open type

货号	中心距	边距	方舌	滚珠	方孔	外箱尺寸	数量/箱	毛重/箱	
	CENTRE	BACK SIDE	DEAD BOLT	ROLLER	SPINDLE HOLE	MEAS.	QTY/CTN	G.WT	
	(mm)	(mm)	MATERIAL	MATERIAL	MATERIAL	side length (CM)	(PCS)	(KGS)	
361-20RO	/	20	zinc	iron Roller	/	/	35x31x28	50	18

## 361-20L

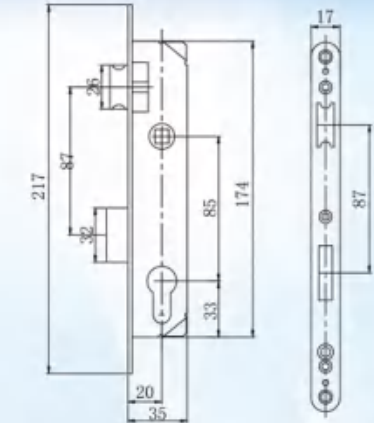

\*open type

货号	中心距	边距	方舌	斜舌	方孔	外箱尺寸	数量/箱	毛重/箱	
	CENTRE	BACK SIDE	DEAD BOLT	LATCH	SPINDLE HOLE	MEAS.	QTY/CTN	G.WT	
	(mm)	(mm)	MATERIAL	MATERIAL	MATERIAL	side length (CM)	(PCS)	(KGS)	
361-20L	85	20	zinc	brass	iron powder	8x8	35x31x28	50	19

## 361-20LO

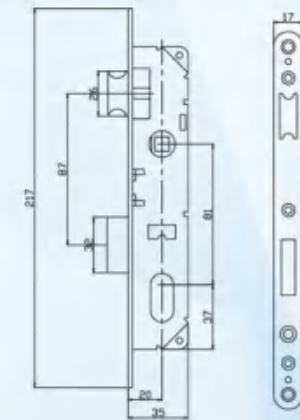

\*open type

货号	中心距	边距	方舌	斜舌	方孔	外箱尺寸	数量/箱	毛重/箱	
	CENTRE	BACK SIDE	DEAD BOLT	LATCH	SPINDLE HOLE	MEAS.	QTY/CTN	G.WT	
	(mm)	(mm)	MATERIAL	MATERIAL	MATERIAL	side length (CM)	(PCS)	(KGS)	
361-20LO	85	20	zinc	brass	iron powder	8x8	35x31x28	50	17

## 4010

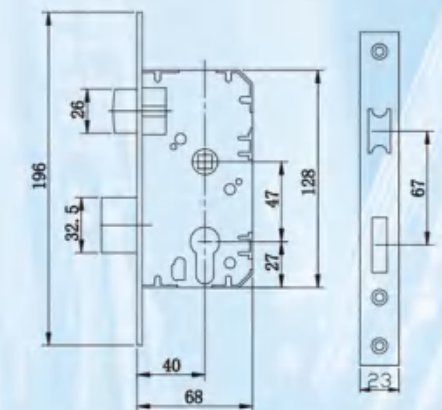
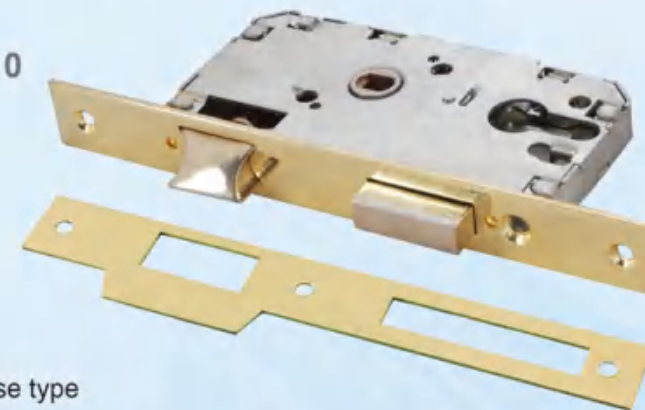

\*close type

货号	中心距	边距	方舌	斜舌	方孔	外箱尺寸	数量/箱	毛重/箱	
	CENTRE	BACK SIDE	DEAD BOLT	LATCH	SPINDLE HOLE	MEAS.	QTY/CTN	G.WT	
	(mm)	(mm)	MATERIAL	MATERIAL	MATERIAL	side length (CM)	(PCS)	(KGS)	
4010	47	40	zinc	zinc	zinc	8x8	45X29X14	30	15



500

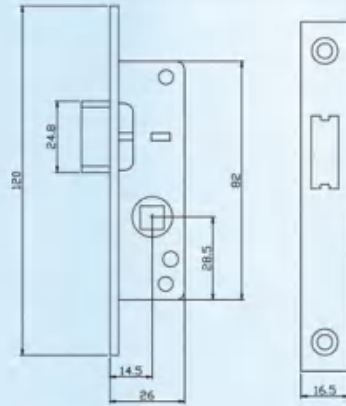

\*open type

货号	中心距	边距	方舌	斜舌	方孔	外箱尺寸	数量/箱	毛重/箱	
	CENTRE	BACK SIDE	DEAD BOLT	LATCH	SPINDLE HOLE	MEAS.	QTY/CTN	G.WT	
	(mm)	(mm)	MATERIAL	MATERIAL	MATERIAL	side length	(CM)	(PCS)	(KGS)
500	/	14.7	/	brass	iron powder	8x8	41x27x18	50	10

500R

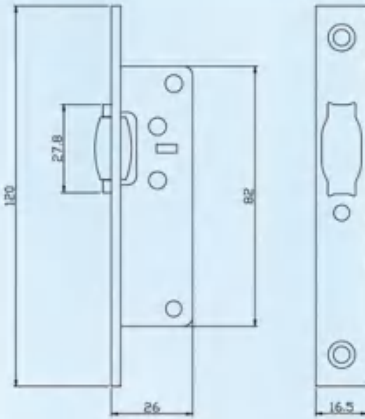

\*open type

货号	中心距	边距	方舌	滚珠	方孔	外箱尺寸	数量/箱	毛重/箱	
	CENTRE	BACK SIDE	DEAD BOLT	ROLLER	SPINDLE HOLE	MEAS.	QTY/CTN	G.WT	
	(mm)	(mm)	MATERIAL	MATERIAL	MATERIAL	side length	(CM)	(PCS)	(KGS)
500R	/	/	/	brass Roller	/	/	4x27x18	50	10

514(740F)

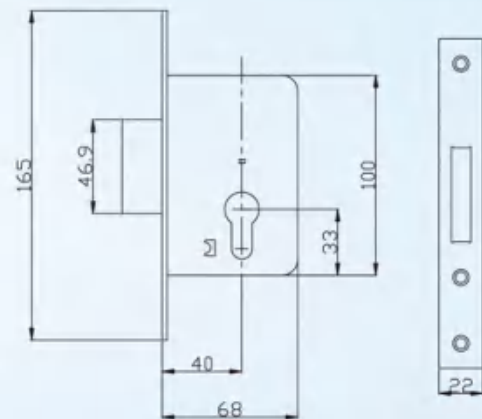

\*open type

货号	中心距	边距	方舌	斜舌	方孔	外箱尺寸	数量/箱	毛重/箱	
	CENTRE	BACK SIDE	DEAD BOLT	LATCH	SPINDLE HOLE	MEAS.	QTY/CTN	G.WT	
	(mm)	(mm)	MATERIAL	MATERIAL	MATERIAL	side length	(CM)	(PCS)	(KGS)
514	/	40	iron	/	/	/	39x29x13	30	12

510.40R

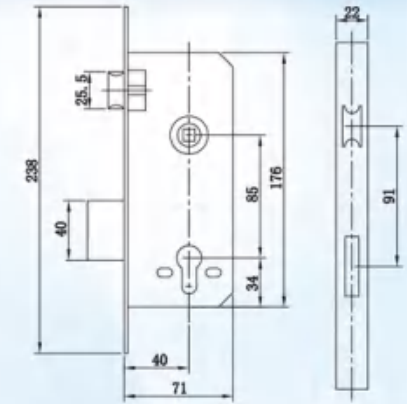
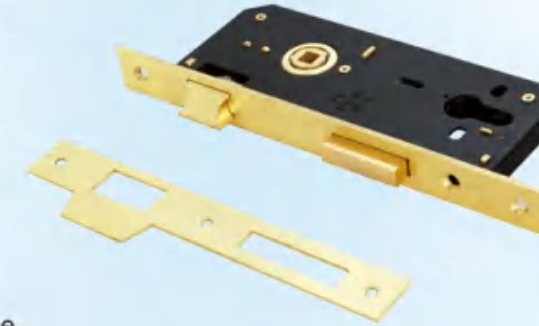

\*close type

货号	中心距	边距	方舌	斜舌	方孔	外箱尺寸	数量/箱	毛重/箱	
	CENTRE	BACK SIDE	DEAD BOLT	LATCH	SPINDLE HOLE	MEAS.	QTY/CTN	G.WT	
	(mm)	(mm)	MATERIAL	MATERIAL	MATERIAL	side length	(CM)	(PCS)	(KGS)
510.40R	85	40	iron/brass	zinc/brass	zinc	8x8	52x29x14	30	19.5

510.45R-3D

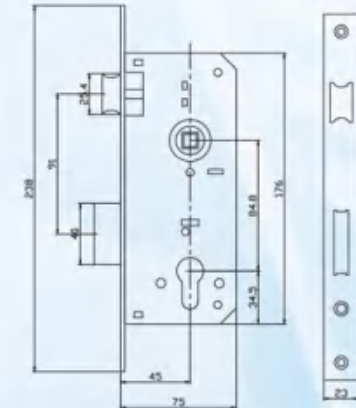

\*close type

货号	中心距	边距	方舌	斜舌	方孔	外箱尺寸	数量/箱	毛重/箱	
	CENTRE	BACK SIDE	DEAD BOLT	LATCH	SPINDLE HOLE	MEAS.	QTY/CTN	G.WT	
	(mm)	(mm)	MATERIAL	MATERIAL	MATERIAL	side length	(CM)	(PCS)	(KGS)
510.45R-3D	84.8	45	iron/brass	zinc/brass	zinc	8x8	52x29x14	30	24

510.70

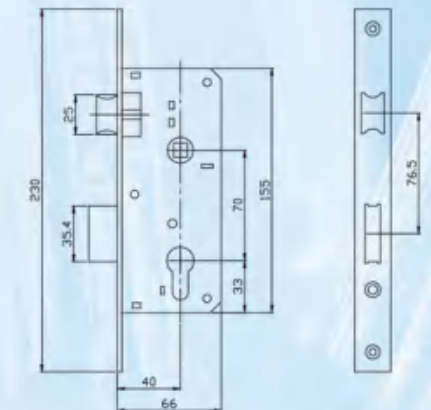
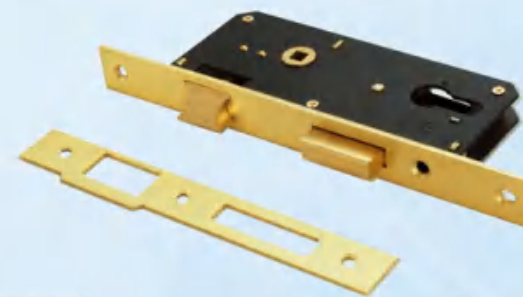

\*open type

货号	中心距	边距	方舌	斜舌	方孔	外箱尺寸	数量/箱	毛重/箱	
	CENTRE	BACK SIDE	DEAD BOLT	LATCH	SPINDLE HOLE	MEAS.	QTY/CTN	G.WT	
	(mm)	(mm)	MATERIAL	MATERIAL	MATERIAL	side length	(CM)	(PCS)	(KGS)
510.70	70	40	iron/brass	iron brass	zinc	6x6	43.5x19x28	30	18.5



520-40  
520-45



A	40	45
B	71	76

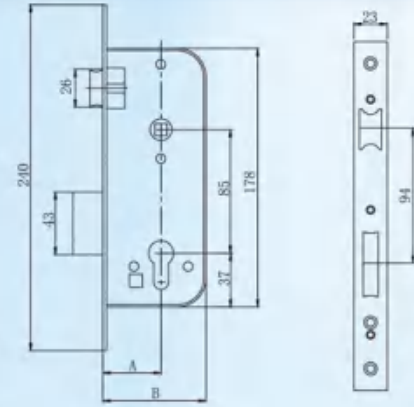

\*close type

货号	中心距	边距	方舌	斜舌	方孔	外箱尺寸	数量/箱	毛重/箱	
	CENTRE	BACK SIDE	DEAD BOLT	LATCH	SPINDLE HOLE	MEAS.	QTY/CTN	G.WT	
	(mm)	(mm)	MATERIAL	MATERIAL	MATERIAL	side length (CM)	(PCS)	(KGS)	
520-40	85	40	iron/brass	zinc/brass	iron powder	8x8	48x27x17	30	21
520-45	85	45	iron/brass	zinc/brass	iron powder	8x8	48x27x17	30	22

520-40K

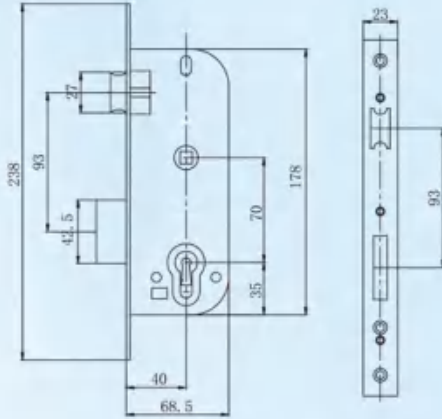

\*close type

货号	中心距	边距	方舌	斜舌	方孔	外箱尺寸	数量/箱	毛重/箱	
	CENTRE	BACK SIDE	DEAD BOLT	LATCH	SPINDLE HOLE	MEAS.	QTY/CTN	G.WT	
	(mm)	(mm)	MATERIAL	MATERIAL	MATERIAL	side length (CM)	(PCS)	(KGS)	
520-40K	70	40	iron/brass	zinc/brass	iron powder	8x8	48x27x17	30	22

5586

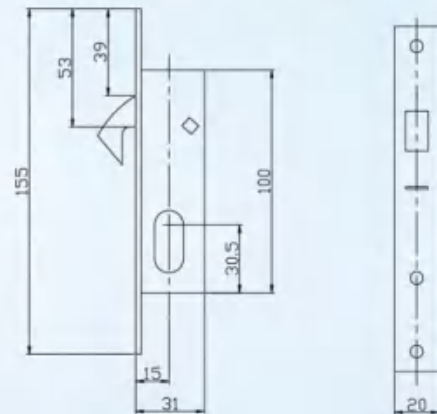

\*open type

货号	中心距	边距	方舌	斜舌	方孔	外箱尺寸	数量/箱	毛重/箱	
	CENTRE	BACK SIDE	DEAD BOLT	LATCH	SPINDLE HOLE	MEAS.	QTY/CTN	G.WT	
	(mm)	(mm)	MATERIAL	MATERIAL	MATERIAL	side length (CM)	(PCS)	(KGS)	
5586	/	15	/	brass hook	/	/	23x22x24	50	13

6000R

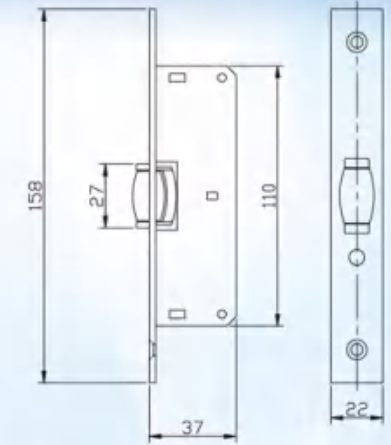

\*open type

货号	中心距	边距	方舌	滚珠	方孔	外箱尺寸	数量/箱	毛重/箱	
	CENTRE	BACK SIDE	DEAD BOLT	ROLLER	SPINDLE HOLE	MEAS.	QTY/CTN	G.WT	
	(mm)	(mm)	MATERIAL	MATERIAL	MATERIAL	side length (CM)	(PCS)	(KGS)	
6000R	/	/	/	brass Roller	/	/	35x27x15	50	13

6000RS

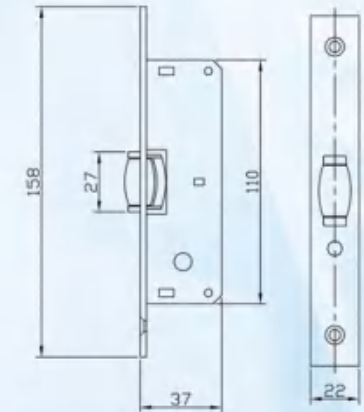

\*open type

货号	中心距	边距	方舌	滚珠	方孔	外箱尺寸	数量/箱	毛重/箱	
	CENTRE	BACK SIDE	DEAD BOLT	ROLLER	SPINDLE HOLE	MEAS.	QTY/CTN	G.WT	
	(mm)	(mm)	MATERIAL	MATERIAL	MATERIAL	side length (CM)	(PCS)	(KGS)	
6000RS	/	/	/	brass Roller	/	/	35x27x15	50	13

6025

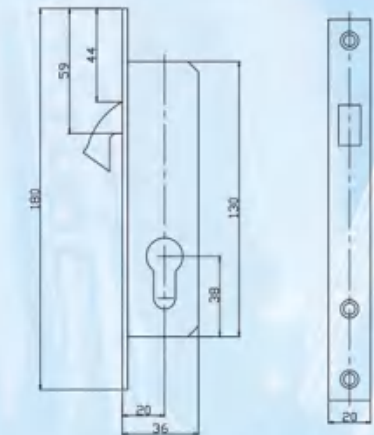

\*open type

货号	中心距	边距	方舌	斜舌	方孔	外箱尺寸	数量/箱	毛重/箱	
	CENTRE	BACK SIDE	DEAD BOLT	LATCH	SPINDLE HOLE	MEAS.	QTY/CTN	G.WT	
	(mm)	(mm)	MATERIAL	MATERIAL	MATERIAL	side length (CM)	(PCS)	(KGS)	
6025	/	20	/	zinc hook	/	/	33x21x31	30	10



### 6005R

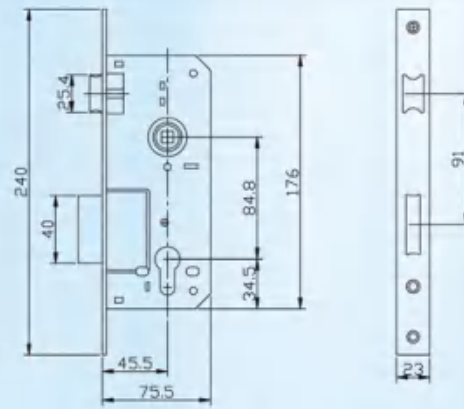

\*close type

货号	中心距	边距	方舌	斜舌	方 孔	外箱尺寸	数量/箱	毛重/箱	
	CENTRE	BACK SIDE	DEAD BOLT	LATCH	SPINDLE HOLE	MEAS.	QTY/CTN	G.WT	
	(mm)	(mm)	MATERIAL	MATERIAL	MATERIAL	side length (CM)	(PCS)	(KGS)	
6005R (6005R II)	85	45.5	iron/brass	zinc/brass	zinc	8X8	52X29X14	30	24

### 6010BT

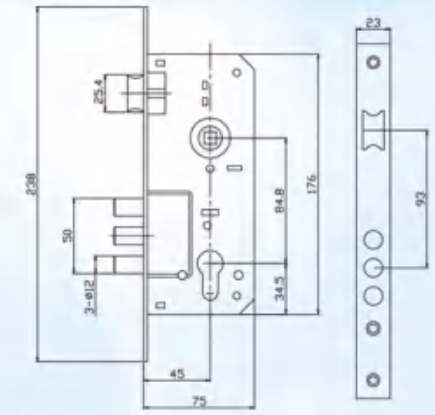
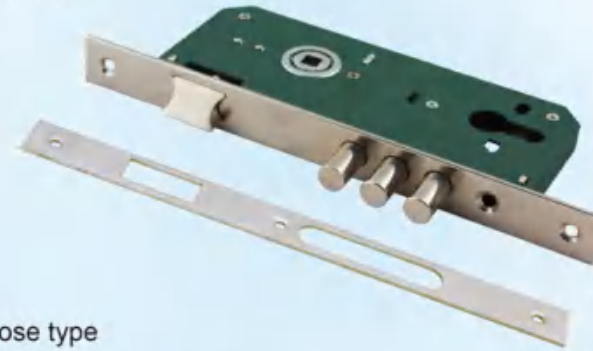

\*close type

货号	中心距	边距	方舌	斜舌	方 孔	外箱尺寸	数量/箱	毛重/箱	
	CENTRE	BACK SIDE	DEAD BOLT	LATCH	SPINDLE HOLE	MEAS.	QTY/CTN	G.WT	
	(mm)	(mm)	MATERIAL	MATERIAL	MATERIAL	side length (CM)	(PCS)	(KGS)	
6010BT	84.8	45	3 ROD	zinc/brass	zinc	8X8	52x29x14	30	24

### 6005R-3R

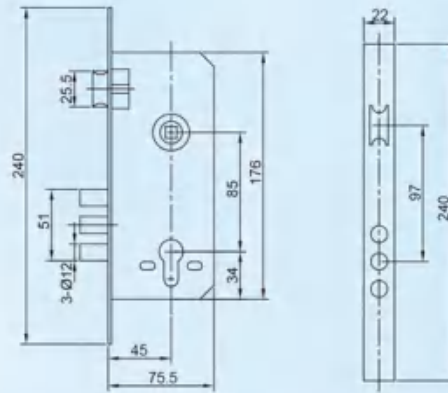

\*close type

货号	中心距	边距	方舌	斜舌	方 孔	外箱尺寸	数量/箱	毛重/箱	
	CENTRE	BACK SIDE	DEAD BOLT	LATCH	SPINDLE HOLE	MEAS.	QTY/CTN	G.WT	
	(mm)	(mm)	MATERIAL	MATERIAL	MATERIAL	side length (CM)	(PCS)	(KGS)	
6005R-3R	85	45	3 ROD	zinc/brass	zinc	8X8	52x29x14	30	24

### 6050-3R

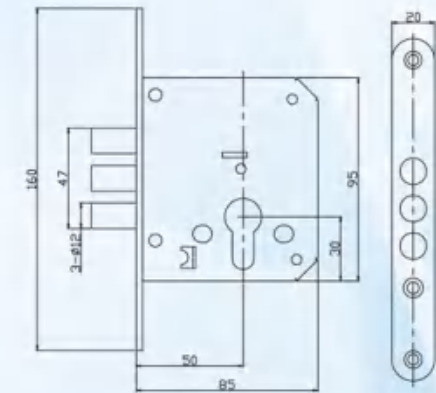

\*close type

货号	中心距	边距	方舌	斜舌	方 孔	外箱尺寸	数量/箱	毛重/箱
	CENTRE	BACK SIDE	DEAD BOLT	LATCH	SPINDLE HOLE	MEAS.	QTY/CTN	G.WT
	(mm)	(mm)	MATERIAL	MATERIAL	MATERIAL	side length (CM)	(PCS)	(KGS)
6050-3R	/	50	3 ROD	/	/	43x30x14	30	13

### 6005-III(85X40) 6005-III(85X45)

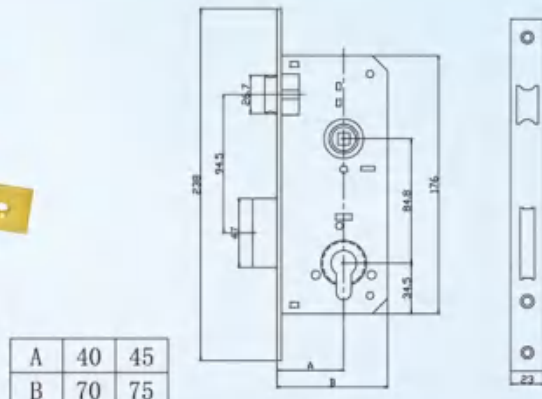
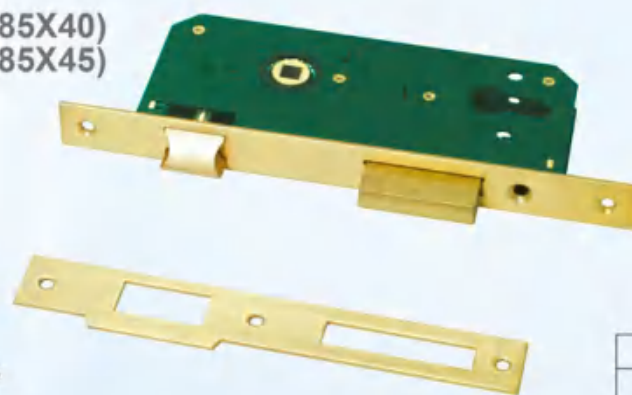

\*open type

货号	中心距	边距	方舌	斜舌	方 孔	外箱尺寸	数量/箱	毛重/箱	
	CENTRE	BACK SIDE	DEAD BOLT	LATCH	SPINDLE HOLE	MEAS.	QTY/CTN	G.WT	
	(mm)	(mm)	MATERIAL	MATERIAL	MATERIAL	side length (CM)	(PCS)	(KGS)	
6005-III (85X40)	85	40	iron/brass	zinc/brass	zinc	8x8	52x29x14	30	22.5
6005-III (85X45)	85	45	iron/brass	zinc/brass	zinc	8x8	52x29x14	30	23

### 6050-72

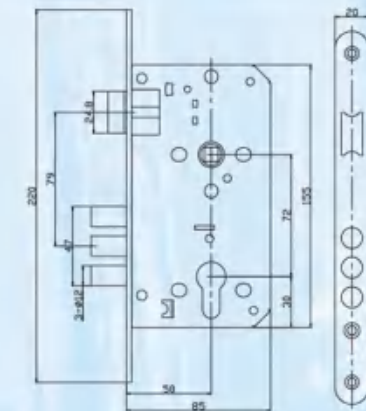

\*close type

货号	中心距	边距	方舌	斜舌	方 孔	外箱尺寸	数量/箱	毛重/箱	
	CENTRE	BACK SIDE	DEAD BOLT	LATCH	SPINDLE HOLE	MEAS.	QTY/CTN	G.WT	
	(mm)	(mm)	MATERIAL	MATERIAL	MATERIAL	side length (CM)	(PCS)	(KGS)	
6050-72	72	50	3 ROD	zinc	zinc	8X8	49x27x17	30	23



## 6010BK

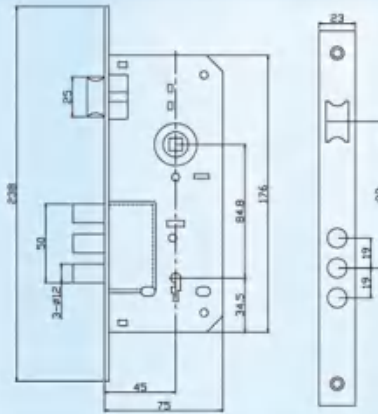

\*close type

货号	中心距	边距	方舌	斜舌	方孔	外箱尺寸	数量/箱	毛重/箱	
	CENTRE	BACK SIDE	DEAD BOLT	LATCH	SPINDLE HOLE	MEAS.	QTY/CTN	G.WT	
	(mm)	(mm)	MATERIAL	MATERIAL	MATERIAL	side length (CM)	(PCS)	(KGS)	
6010BK	84.8	45	iron/brass	zinc/brass	zinc	8x8	49x27x17	30	23.5

## 6110BB

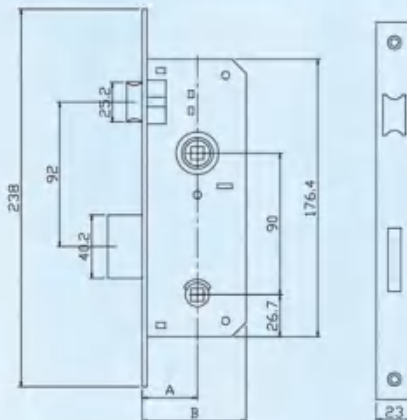

\*close type

A	35	40
B	66	71

货号	中心距	边距	方舌	斜舌	方孔	外箱尺寸	数量/箱	毛重/箱	
	CENTRE	BACK SIDE	DEAD BOLT	LATCH	SPINDLE HOLE	MEAS.	QTY/CTN	G.WT	
	(mm)	(mm)	MATERIAL	MATERIAL	MATERIAL	side length (CM)	(PCS)	(KGS)	
6110BB	90	35	iron/brass	zinc/brass	zinc	8x8,6x6	52X29X14	30	21
6110BB	90	40	iron/brass	zinc/brass	zinc	8x8,6x6	52X29X14	30	21

## 6110BK

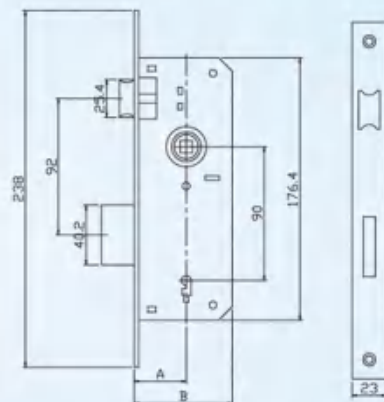
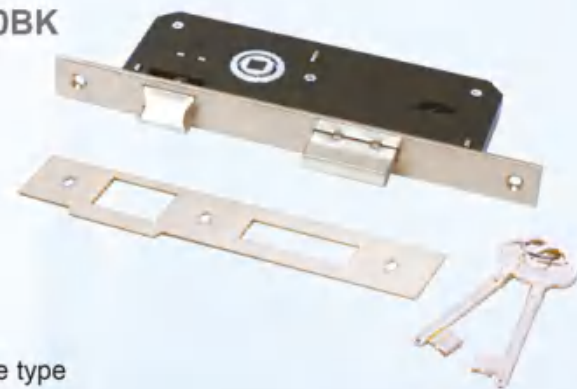

\*close type

A	35	40
B	66	71

货号	中心距	边距	方舌	斜舌	方孔	外箱尺寸	数量/箱	毛重/箱	
	CENTRE	BACK SIDE	DEAD BOLT	LATCH	SPINDLE HOLE	MEAS.	QTY/CTN	G.WT	
	(mm)	(mm)	MATERIAL	MATERIAL	MATERIAL	side length (CM)	(PCS)	(KGS)	
6110BK	90	35	iron/brass	zinc/brass	zinc	8x8	52X29X14	30	22
6110BK	90	40	iron/brass	zinc/brass	zinc	8x8	52X29X14	30	22

## 6110

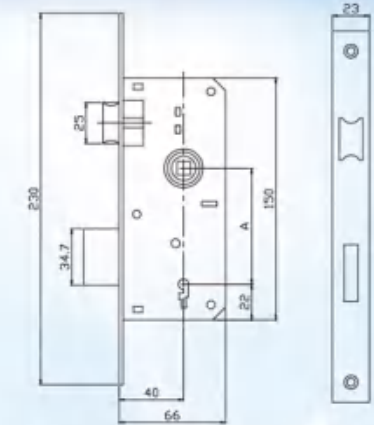

\*open type

货号	中心距	边距	方舌	斜舌	方孔	外箱尺寸	数量/箱	毛重/箱	
	CENTRE	BACK SIDE	DEAD BOLT	LATCH	SPINDLE HOLE	MEAS.	QTY/CTN	G.WT	
	(mm)	(mm)	MATERIAL	MATERIAL	MATERIAL	side length (CM)	(PCS)	(KGS)	
6110	72/70	40	iron/brass	zinc/brass	zinc	8x8	43x27x17	30	19

## 6115

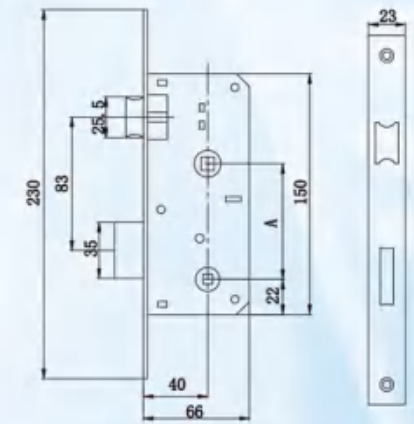
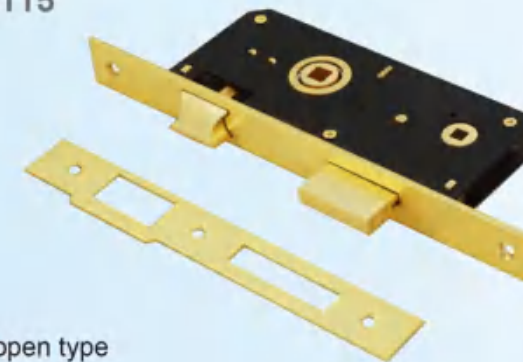

\*open type

货号	中心距	边距	方舌	斜舌	方孔	外箱尺寸	数量/箱	毛重/箱	
	CENTRE	BACK SIDE	DEAD BOLT	LATCH	SPINDLE HOLE	MEAS.	QTY/CTN	G.WT	
	(mm)	(mm)	MATERIAL	MATERIAL	MATERIAL	side length (CM)	(PCS)	(KGS)	
6115	72/70	40	iron/brass	zinc/brass	zinc	8x8,6x6	43X27X17	30	18

## 6110A

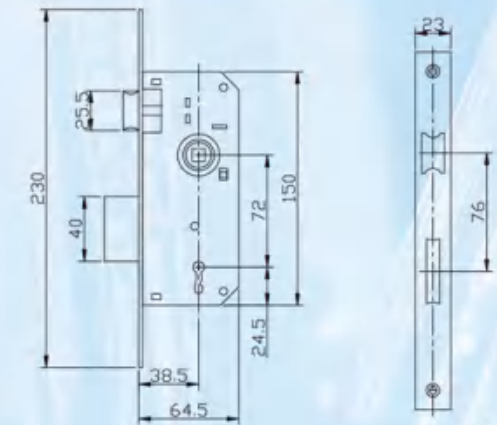
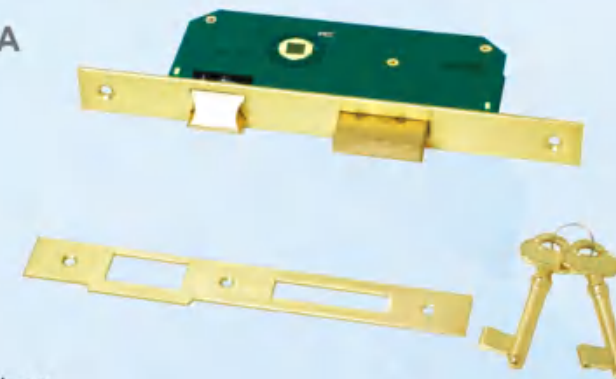

\*open type

货号	中心距	边距	方舌	斜舌	方孔	外箱尺寸	数量/箱	毛重/箱	
	CENTRE	BACK SIDE	DEAD BOLT	LATCH	SPINDLE HOLE	MEAS.	QTY/CTN	G.WT	
	(mm)	(mm)	MATERIAL	MATERIAL	MATERIAL	side length (CM)	(PCS)	(KGS)	
6110A	72	38.5	iron/zinc	zinc/brass	zinc	8x8	43x26x21	30	19



6115A

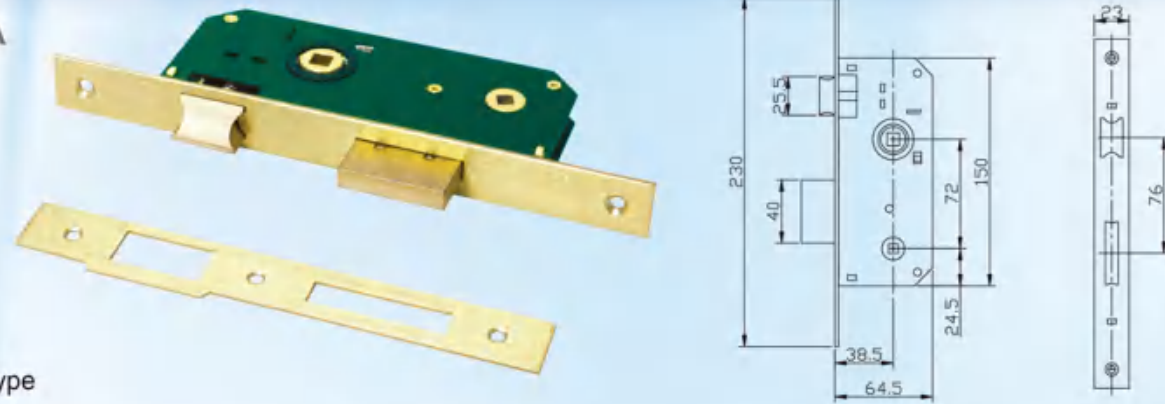

\*open type

货号	中心距	边距	方舌	斜舌	方 孔	外箱尺寸	数量/箱	毛重/箱	
	CENTRE	BACK SIDE	DEAD BOLT	LATCH	SPINDLE HOLE	MEAS.	QTY/CTN	G.WT	
	(mm)	(mm)	MATERIAL	MATERIAL	MATERIAL	side length	(PCS)	(KGS)	
6115A	72	38.5	iron/zinc	zinc/brass	zinc	8x8 6x6	43x26x21	30	18

7011CK



\*open type

货号	中心距	边距	方舌	斜舌	方 孔	外箱尺寸	数量/箱	毛重/箱	
	CENTRE	BACK SIDE	DEAD BOLT	LATCH	SPINDLE HOLE	MEAS.	QTY/CTN	G.WT	
	(mm)	(mm)	MATERIAL	MATERIAL	MATERIAL	side length	(PCS)	(KGS)	
7011CK	90	43	iron	zinc	zinc	8x8	53x29x14	30	19

7010BB



\*open type

货号	中心距	边距	方舌	斜舌	方 孔	外箱尺寸	数量/箱	毛重/箱	
	CENTRE	BACK SIDE	DEAD BOLT	LATCH	SPINDLE HOLE	MEAS.	QTY/CTN	G.WT	
	(mm)	(mm)	MATERIAL	MATERIAL	MATERIAL	side length	(PCS)	(KGS)	
7010BB	72	40	iron/brass	zinc/brass	zinc	8x8, 6x6	42x27x17	30	17.5

7011SR

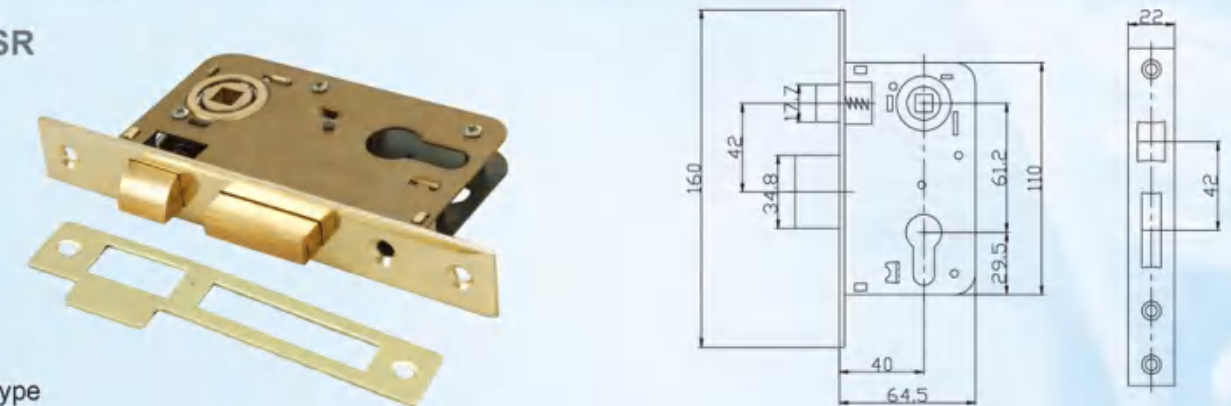

\*open type

货号	中心距	边距	方舌	斜舌	方 孔	外箱尺寸	数量/箱	毛重/箱	
	CENTRE	BACK SIDE	DEAD BOLT	LATCH	SPINDLE HOLE	MEAS.	QTY/CTN	G.WT	
	(mm)	(mm)	MATERIAL	MATERIAL	MATERIAL	side length	(PCS)	(KGS)	
7011SR	61.2	40	iron/brass	brass	zinc	8x8	39x29x13	30	13.5

7010BK



\*open type

货号	中心距	边距	方舌	斜舌	方 孔	外箱尺寸	数量/箱	毛重/箱	
	CENTRE	BACK SIDE	DEAD BOLT	LATCH	SPINDLE HOLE	MEAS.	QTY/CTN	G.WT	
	(mm)	(mm)	MATERIAL	MATERIAL	MATERIAL	side length	(PCS)	(KGS)	
7010BK	72	40	iron/brass	zinc/brass	zinc	8x8	42x27x17	30	18.5

7011S-3R

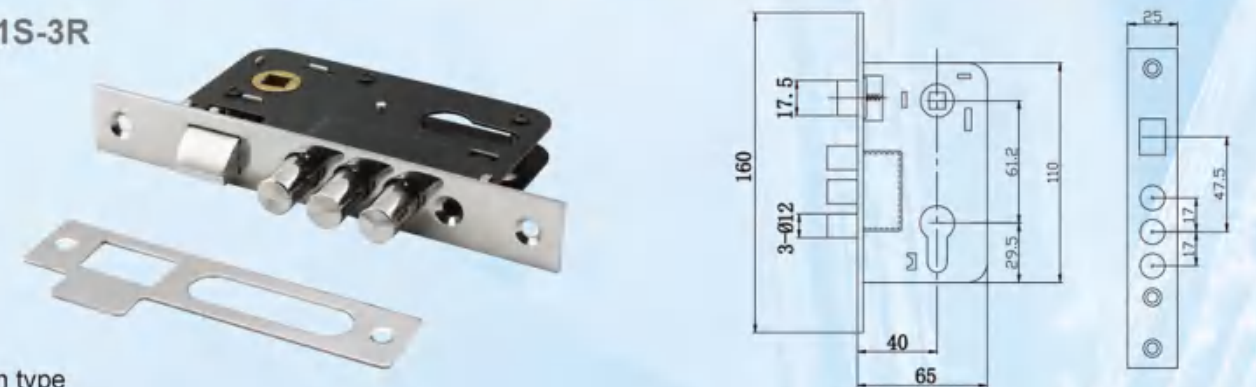

\*open type

货号	中心距	边距	方舌	滚珠	方 孔	外箱尺寸	数量/箱	毛重/箱	
	CENTRE	BACK SIDE	DEAD BOLT	ROLLER	SPINDLE HOLE	MEAS.	QTY/CTN	G.WT	
	(mm)	(mm)	MATERIAL	MATERIAL	MATERIAL	side length	(PCS)	(KGS)	
7011S-3R	61.2	40	3 ROD	brass	zinc	8x8	39x29x13	30	13



## 7011SR-3R

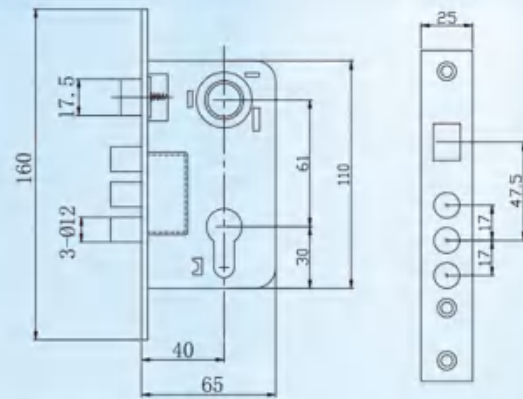

\*open type

货号	中心距	边距	方舌	斜舌	方孔	外箱尺寸	数量/箱	毛重/箱	
	CENTRE	BACK SIDE	DEAD BOLT	LATCH	SPINDLE HOLE	MEAS.	QTY/CTN	G.WT	
	(mm)	(mm)	MATERIAL	MATERIAL	MATERIAL	side length	(PCS)	(KGS)	
7011SR-3R	61	40	3 ROD	brass	zinc	8x8	39x29x13	30	13.5

## 7011BC

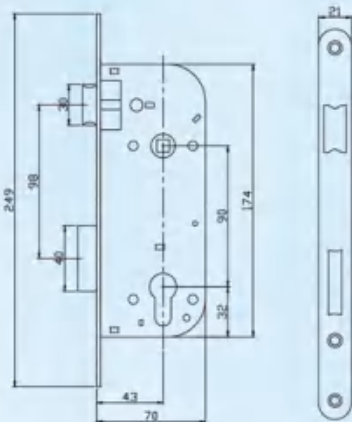

\*open type

货号	中心距	边距	方舌	斜舌	方孔	外箱尺寸	数量/箱	毛重/箱	
	CENTRE	BACK SIDE	DEAD BOLT	LATCH	SPINDLE HOLE	MEAS.	QTY/CTN	G.WT	
	(mm)	(mm)	MATERIAL	MATERIAL	MATERIAL	side length	(PCS)	(KGS)	
7011BC	90	43	zinc	zinc	zinc	8x8	53x29x14	30	18

## 7011CC

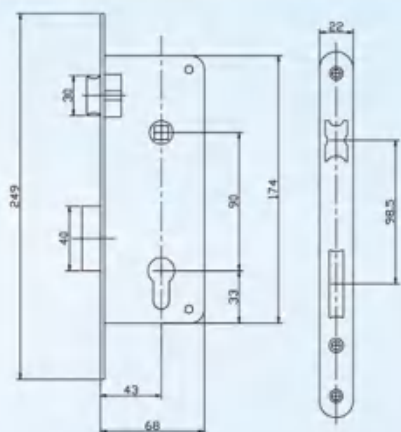

\*open type

货号	中心距	边距	方舌	斜舌	方孔	外箱尺寸	数量/箱	毛重/箱	
	CENTRE	BACK SIDE	DEAD BOLT	LATCH	SPINDLE HOLE	MEAS.	QTY/CTN	G.WT	
	(mm)	(mm)	MATERIAL	MATERIAL	MATERIAL	side length	(PCS)	(KGS)	
7011CC	90	43	iron	zinc	zinc	8x8	53x29x14	30	18

## 7011A

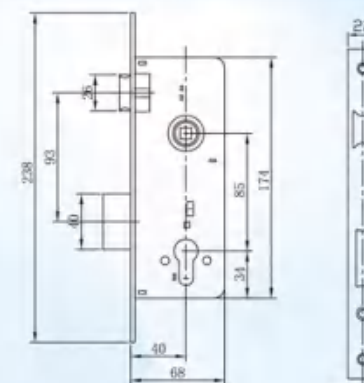

\*open type

货号	中心距	边距	方舌	斜舌	方孔	外箱尺寸	数量/箱	毛重/箱	
	CENTRE	BACK SIDE	DEAD BOLT	LATCH	SPINDLE HOLE	MEAS.	QTY/CTN	G.WT	
	(mm)	(mm)	MATERIAL	MATERIAL	MATERIAL	side length	(PCS)	(KGS)	
7011A	85	40	iron/brass	zinc/brass	zinc	8x8	53x29x14	30	19

## 7011AF

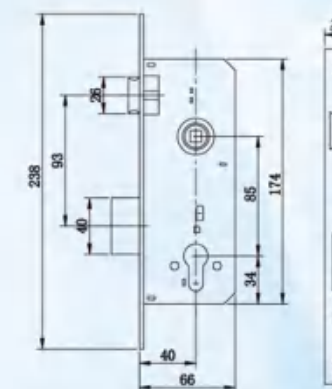
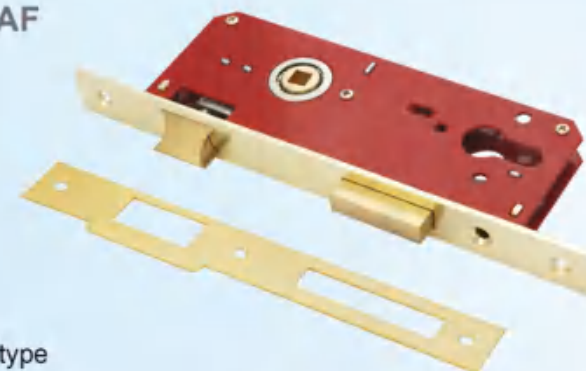

\*open type

货号	中心距	边距	方舌	斜舌	方孔	外箱尺寸	数量/箱	毛重/箱	
	CENTRE	BACK SIDE	DEAD BOLT	LATCH	SPINDLE HOLE	MEAS.	QTY/CTN	G.WT	
	(mm)	(mm)	MATERIAL	MATERIAL	MATERIAL	side length	(PCS)	(KGS)	
7011AF	85	40	iron/brass	zinc/brass	zinc	8x8	53x29x14	30	18

## 7011R-35 7011R-40 7011R-45 7011R-50 7011R-55 7011R-60

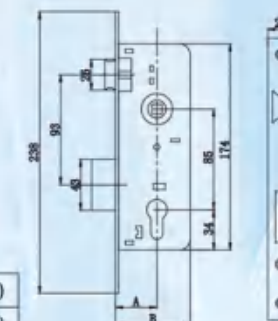

\*open type

货号	中心距	边距	方舌	斜舌	方孔	外箱尺寸	数量/箱	毛重/箱	
	CENTRE	BACK SIDE	DEAD BOLT	LATCH	SPINDLE HOLE	MEAS.	QTY/CTN	G.WT	
	(mm)	(mm)	MATERIAL	MATERIAL	MATERIAL	side length	(PCS)	(KGS)	
7011R-35	85	35	iron/brass	zinc/brass	zinc	8x8	53X29X14	30	17.5
7011R-40	85	40	iron/brass	zinc/brass	zinc	8x8	53X29X14	30	18.5
7011R-45	85	45	iron/brass	zinc/brass	zinc	8x8	53X29X14	30	19.5
7011R-50	85	50	iron/brass	zinc/brass	zinc	8x8	53X29X14	30	20.5
7011R-55	85	55	iron/brass	zinc/brass	zinc	8x8	53X29X14	30	21.5
7011R-60	85	60	iron/brass	zinc/brass	zinc	8x8	53X29X14	30	22.5

A	35	40	45	50	55	60
B	63	68	73	78	83	88



7011-35  
7011-40  
7011-45  
7011-50  
7011-55  
7011-60



A	35	40	45	55	60
B	63	68	73	83	88

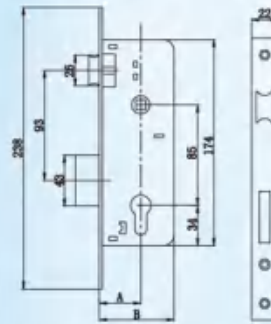

\*open type

货号	中心距	边距	方舌	斜舌	方孔	外箱尺寸	数量/箱	毛重/箱	
	CENTRE	BACK SIDE	DEAD BOLT	LATCH	SPINDLE HOLE	MEAS.	QTY/CTN	G.WT	
	(mm)	(mm)	MATERIAL	MATERIAL	MATERIAL	side length	(PCS)	(KGS)	
7011-35	85	35	iron/brass	zinc/brass	iron powder	8x8	53X29X14	30	18
7011-40	85	40	iron/brass	zinc/brass	iron powder	8x8	53X29X14	30	18.5
7011-45	85	45	iron/brass	zinc/brass	iron powder	8x8	53X29X14	30	19.5
7011-50	85	55	iron/brass	zinc/brass	iron powder	8x8	53X29X14	30	20.5
7011-55	85	60	iron/brass	zinc/brass	iron powder	8x8	53X29X14	30	21.5
7011-60	85	70	iron/brass	zinc/brass	iron powder	8x8	47X28X16	30	22.5

7012

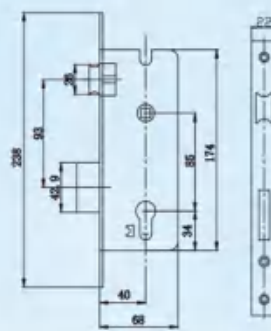

\*open type

货号	中心距	边距	方舌	斜舌	方孔	外箱尺寸	数量/箱	毛重/箱	
	CENTRE	BACK SIDE	DEAD BOLT	LATCH	SPINDLE HOLE	MEAS.	QTY/CTN	G.WT	
	(mm)	(mm)	MATERIAL	MATERIAL	MATERIAL	side length	(PCS)	(KGS)	
7012	85/70	40	iron/brass	zinc/brass	zinc	8x8	49X27X17	30	19

7013-40  
7013-45



A	40	45
B	67	72

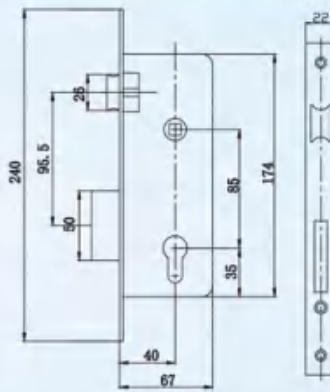

\*open type

货号	中心距	边距	方舌	斜舌	方孔	外箱尺寸	数量/箱	毛重/箱	
	CENTRE	BACK SIDE	DEAD BOLT	LATCH	SPINDLE HOLE	MEAS.	QTY/CTN	G.WT	
	(mm)	(mm)	MATERIAL	MATERIAL	MATERIAL	side length	(PCS)	(KGS)	
7013-40	85	40	iron/brass	zinc/brass	iron powder	8x8	53x29x14	30	20.5
7013-45	85	45	iron/brass	zinc/brass	iron powder	8x8	53x29x14	30	21

7014

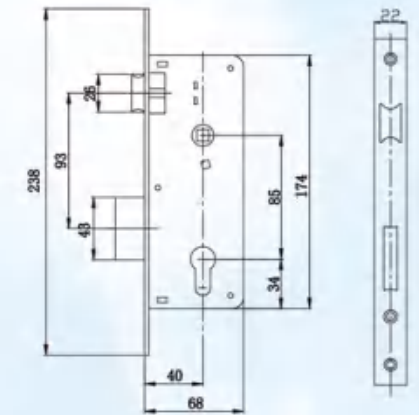
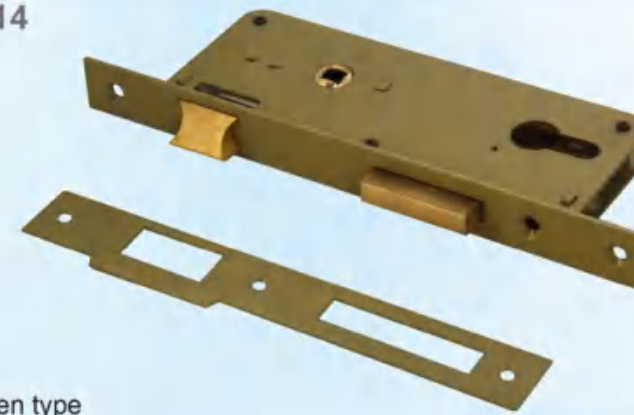

\*open type

货号	中心距	边距	方舌	斜舌	方孔	外箱尺寸	数量/箱	毛重/箱	
	CENTRE	BACK SIDE	DEAD BOLT	LATCH	SPINDLE HOLE	MEAS.	QTY/CTN	G.WT	
	(mm)	(mm)	MATERIAL	MATERIAL	MATERIAL	side length	(PCS)	(KGS)	
7014	85	40	iron/brass	zinc/brass	iron	8x8	53x29x14	30	19

7015

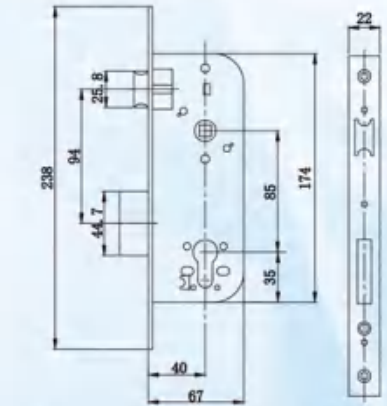
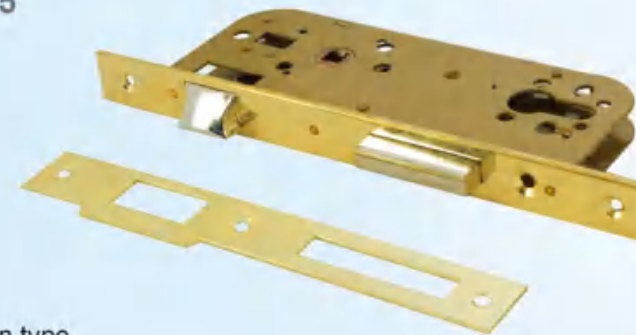

\*open type

货号	中心距	边距	方舌	斜舌	方孔	外箱尺寸	数量/箱	毛重/箱	
	CENTRE	BACK SIDE	DEAD BOLT	LATCH	SPINDLE HOLE	MEAS.	QTY/CTN	G.WT	
	(mm)	(mm)	MATERIAL	MATERIAL	MATERIAL	side length	(PCS)	(KGS)	
7015	85	40	iron/brass	zinc/brass	zinc	8x8	53x29x14	30	20

7016-40

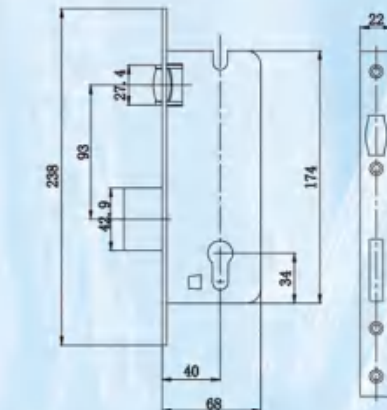

\*open type

货号	中心距	边距	方舌	滚珠	方孔	外箱尺寸	数量/箱	毛重/箱	
	CENTRE	BACK SIDE	DEAD BOLT	ROLLER	SPINDLE HOLE	MEAS.	QTY/CTN	G.WT	
	(mm)	(mm)	MATERIAL	MATERIAL	MATERIAL	side length	(PCS)	(KGS)	
7016-40	/	40	iron/brass	brass roller	/	/	53x29x14	30	18



### 7017

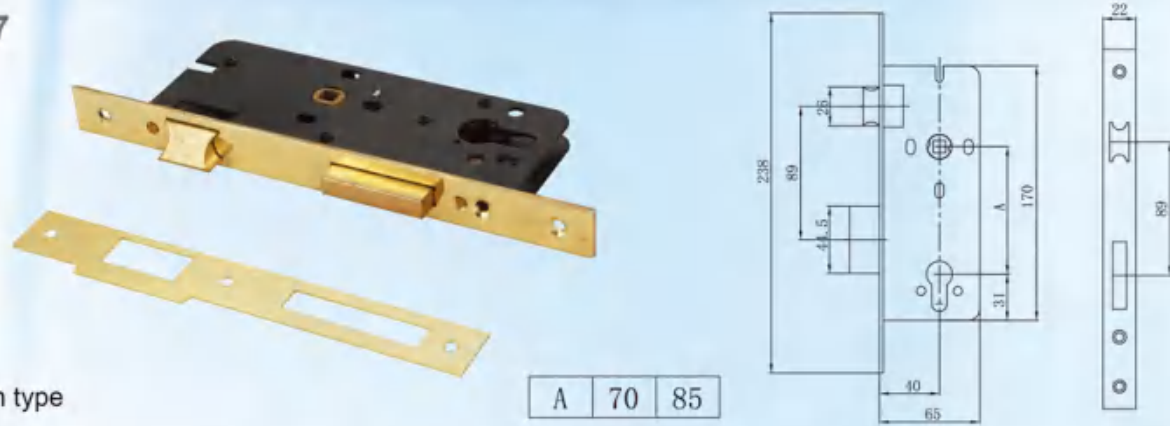

\*open type

货号	中心距	边距	方舌	斜舌	方孔	外箱尺寸	数量/箱	毛重/箱
	CENTRE	BACK SIDE	DEAD BOLT	LATCH	SPINDLE HOLE	MEAS.	QTY/CTN	G.WT
	(mm)	(mm)	MATERIAL	MATERIAL	MATERIAL	side length	(PCS)	(KGS)
7017 (40x70)	70	40	iron/brass	zinc/brass	zinc	8x8	30	20
7017 (40x85)	85	40	iron/brass	zinc/brass	zinc	8x8	30	20

### 7018A

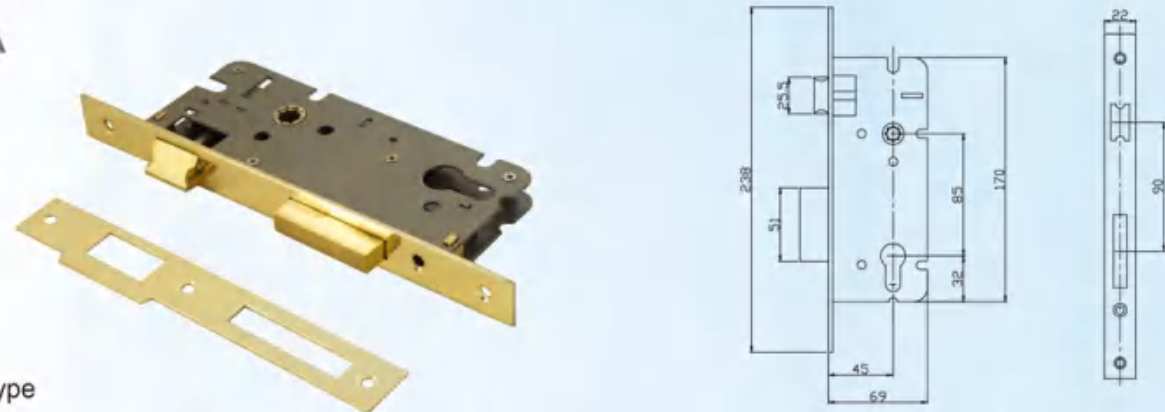

\*open type

货号	中心距	边距	方舌	斜舌	方孔	外箱尺寸	数量/箱	毛重/箱
	CENTRE	BACK SIDE	DEAD BOLT	LATCH	SPINDLE HOLE	MEAS.	QTY/CTN	G.WT
	(mm)	(mm)	MATERIAL	MATERIAL	MATERIAL	side length	(PCS)	(KGS)
7018A	85	45	iron/brass	zinc/brass	zinc	8x8	30	21

### 7018-3F



\*open type

货号	中心距	边距	方舌	斜舌	方孔	外箱尺寸	数量/箱	毛重/箱
	CENTRE	BACK SIDE	DEAD BOLT	LATCH	SPINDLE HOLE	MEAS.	QTY/CTN	G.WT
	(mm)	(mm)	MATERIAL	MATERIAL	MATERIAL	side length	(PCS)	(KGS)
7018-3F	85	45	3 SQUARE ROD iron/brass	zinc/brass	zinc	8x8	30	21

### 7025-40 7025-45 7025-50

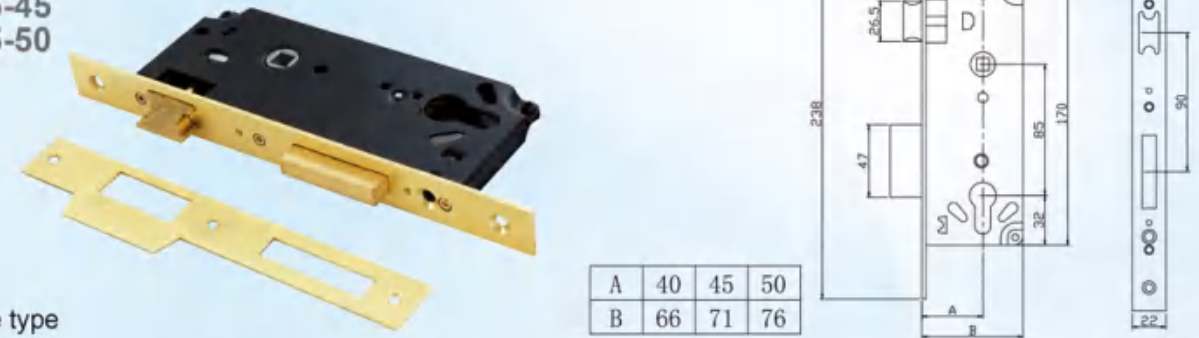

\*close type

货号	中心距	边距	方舌	斜舌	方孔	外箱尺寸	数量/箱	毛重/箱	
	CENTRE	BACK SIDE	DEAD BOLT	LATCH	SPINDLE HOLE	MEAS.	QTY/CTN	G.WT	
	(mm)	(mm)	MATERIAL	MATERIAL	MATERIAL	side length	(PCS)	(KGS)	
7025-40	85	40	iron/brass	zinc/brass	zinc	8x8	49X27X17	30	20
7025-45	85	45	iron/brass	zinc/brass	zinc	8x8	49X27X17	30	21
7025-50	85	50	iron/brass	zinc/brass	zinc	8x8	49X27X17	30	22

### 7028-45C

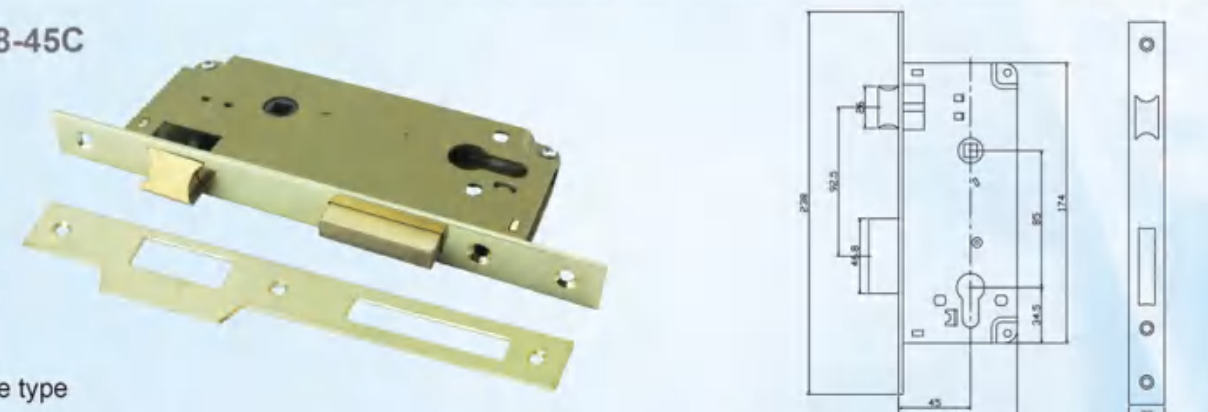

\*close type

货号	中心距	边距	方舌	斜舌	方孔	外箱尺寸	数量/箱	毛重/箱	
	CENTRE	BACK SIDE	DEAD BOLT	LATCH	SPINDLE HOLE	MEAS.	QTY/CTN	G.WT	
	(mm)	(mm)	MATERIAL	MATERIAL	MATERIAL	side length	(PCS)	(KGS)	
7028-45C	85	45	iron/brass	zinc/brass	iron powder	8x8	49x27x17	30	22

### 7040



\*close type

货号	中心距	边距	方舌	斜舌	方孔	外箱尺寸	数量/箱	毛重/箱	
	CENTRE	BACK SIDE	DEAD BOLT	LATCH	SPINDLE HOLE	MEAS.	QTY/CTN	G.WT	
	(mm)	(mm)	MATERIAL	MATERIAL	MATERIAL	side length	(PCS)	(KGS)	
7040	85	40	brass	brass	brass	8x8	40x30x14.5	25	16.5



720A  
725A  
730A  
735A

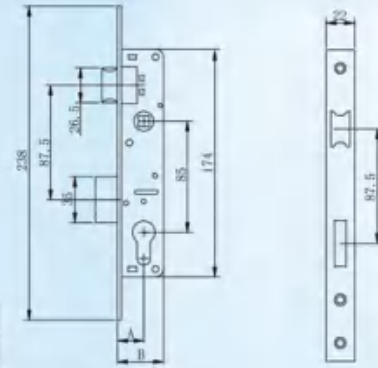
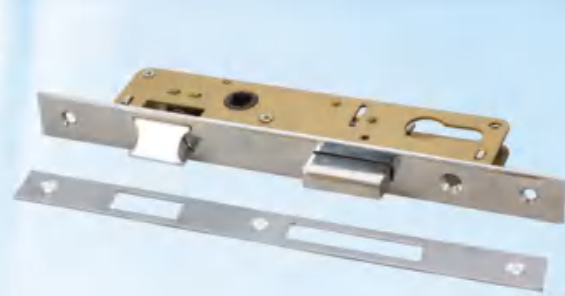

A	20	25	30	35
B	36	40	46	51

\*open type

货号	中心距	边距	方舌	斜舌	方 孔	外箱尺寸	数量/箱	毛重/箱	
	CENTRE	BACK SIDE	DEAD BOLT	LATCH	SPINDLE HOLE	MEAS.	QTY/CTN	G.WT	
	(mm)	(mm)	MATERIAL	MATERIAL	MATERIAL	side length (CM)	(PCS)	(KGS)	
720A	85	20	zinc/brass	zinc/brass	iron powder	8x8	39X26.5X14	30	13.5
725A	85	25	zinc/brass	zinc/brass	iron powder	8x8	39X26.5X14	30	14.5
730A	85	30	zinc/brass	zinc/brass	iron powder	8x8	39X26.5X14	30	15.5
735A	85	35	zinc/brass	zinc/brass	iron powder	8x8	39X26.5X14	30	16.5

720  
730

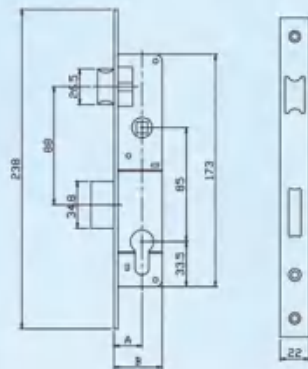

A	20	30
B	36	46

\*open type

货号	中心距	边距	方舌	斜舌	方 孔	外箱尺寸	数量/箱	毛重/箱	
	CENTRE	BACK SIDE	DEAD BOLT	LATCH	SPINDLE HOLE	MEAS.	QTY/CTN	G.WT	
	(mm)	(mm)	MATERIAL	MATERIAL	MATERIAL	side length (CM)	(PCS)	(KGS)	
720	85	20	zinc	zinc/brass	zinc	8x8	39X26.5X14	30	13
730	85	30	zinc	zinc/brass	zinc	8x8	39X26.5X14	30	15

720R  
730R

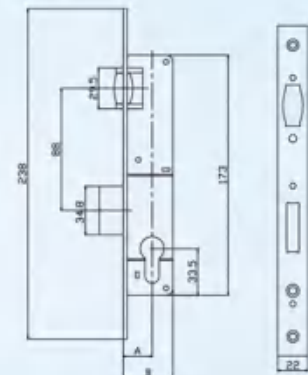

A	20	30
B	36	46

\*open type

货号	中心距	边距	方舌	滚珠	方 孔	外箱尺寸	数量/箱	毛重/箱	
	CENTRE	BACK SIDE	DEAD BOLT	ROLLER	SPINDLE HOLE	MEAS.	QTY/CTN	G.WT	
	(mm)	(mm)	MATERIAL	MATERIAL	MATERIAL	side length (CM)	(PCS)	(KGS)	
720R	/	20	zinc	brass Roller	/	/	39X26.5X14	30	13.5
730R	/	30	zinc	brass Roller	/	/	39X26.5X14	30	15.5

725-C  
735-C

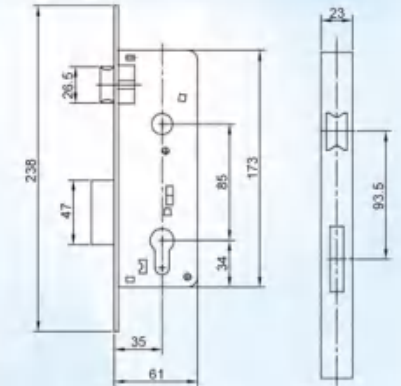

A	25	35
B	51	61

\*open type

货号	中心距	边距	方舌	斜舌	方 孔	外箱尺寸	数量/箱	毛重/箱	
	CENTRE	BACK SIDE	DEAD BOLT	LATCH	SPINDLE HOLE	MEAS.	QTY/CTN	G.WT	
	(mm)	(mm)	MATERIAL	MATERIAL	MATERIAL	side length (CM)	(PCS)	(KGS)	
725-C	85	25	iron/brass	zinc/brass	iron	8x8	39X26.5X14	30	15
735-C	85	35	iron/brass	zinc/brass	iron	8x8	39X26.5X14	30	16

725-D  
730-D  
740-D  
745-D  
740-D 全喷

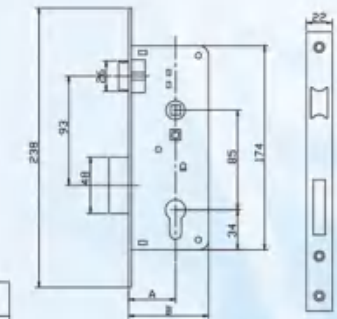
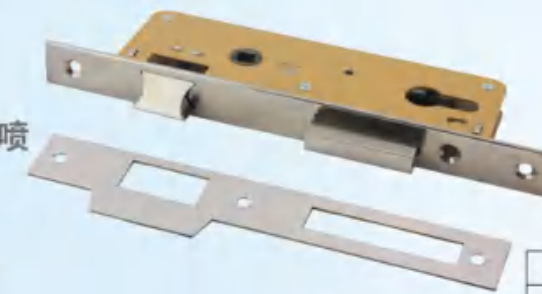

A	25	30	40	45
B	53	58	68	73

\*open type

货号	中心距	边距	方舌	斜舌	方 孔	外箱尺寸	数量/箱	毛重/箱	
	CENTRE	BACK SIDE	DEAD BOLT	LATCH	SPINDLE HOLE	MEAS.	QTY/CTN	G.WT	
	(mm)	(mm)	MATERIAL	MATERIAL	MATERIAL	side length (CM)	(PCS)	(KGS)	
725-D	85	25	iron/brass	zinc/brass	iron powder	8x8	43X28X19	30	17
730-D	85	30	iron/brass	zinc/brass	iron powder	8x8	43X28X19	30	18.5
740-D	85	40	iron/brass	zinc/brass	iron powder	8x8	43X28X19	30	20
745-D	85	45	iron/brass	zinc/brass	iron powder	8x8	43X28X19	30	21
740-D 全喷	85	40	iron/brass	zinc/brass	iron powder	8x8	43X28X19	30	20

725DR  
745DR

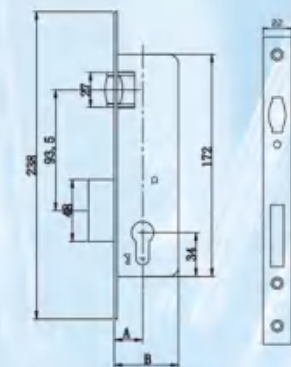

A	25	45
B	53	73

\*open type

货号	中心距	边距	方舌	滚珠	方 孔	外箱尺寸	数量/箱	毛重/箱	
	CENTRE	BACK SIDE	DEAD BOLT	ROLLER	SPINDLE HOLE	MEAS.	QTY/CTN	G.WT	
	(mm)	(mm)	MATERIAL	MATERIAL	MATERIAL	side length (CM)	(PCS)	(KGS)	
725DR	/	25	iron/brass	brass Roller	/	/	43x28x19	30	17
745DR	/	45	iron/brass	brass Roller	/	/	43x28x19	30	19



735DB  
740DB  
745DB

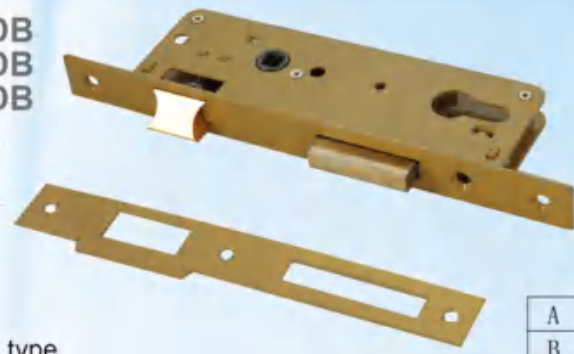

A	35	40	45
B	58	63	68

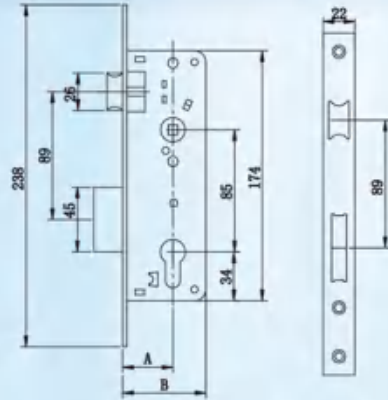

\*open type

货号	中心距	边距	方舌	斜舌	方孔	外箱尺寸	数量/箱	毛重/箱	
	CENTRE	BACK SIDE	DEAD BOLT	LATCH	SPINDLE HOLE	MEAS.	QTY/CTN	G.WT	
	(mm)	(mm)	MATERIAL	MATERIAL	MATERIAL	side length	(PCS)	(KGS)	
735DB	85	35	iron/brass	zinc/brass	iron powder	8x8	43x28x19	30	18
740DB	85	40	iron/brass	zinc/brass	iron powder	8x8	43x28x19	30	18.5
745DB	85	45	iron/brass	zinc/brass	iron powder	8x8	43x28x19	30	19

735R  
745R

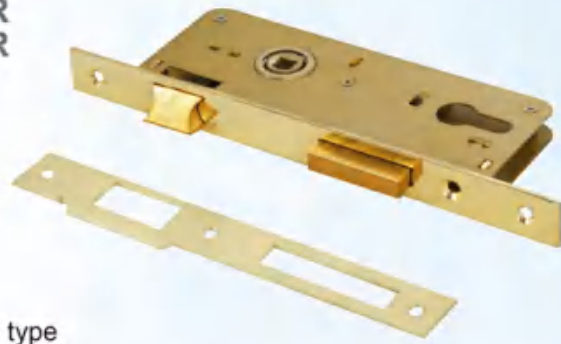

A	35	45
B	62	72

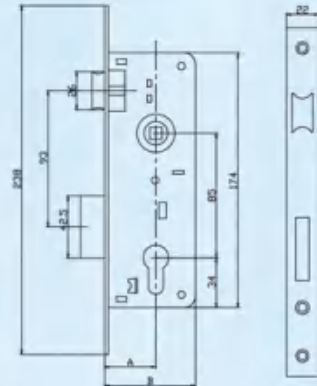

\*open type

货号	中心距	边距	方舌	斜舌	方孔	外箱尺寸	数量/箱	毛重/箱	
	CENTRE	BACK SIDE	DEAD BOLT	LATCH	SPINDLE HOLE	MEAS.	QTY/CTN	G.WT	
	(mm)	(mm)	MATERIAL	MATERIAL	MATERIAL	side length	(PCS)	(KGS)	
735R	85	35	iron/brass	zinc/brass	zinc	8x8	49x27x17	30	17.5
745R	85	45	iron/brass	zinc/brass	zinc	8x8	49x27x17	30	19

745-3R

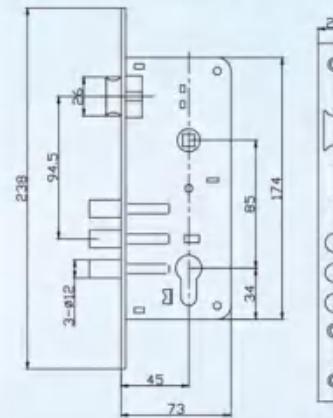

\*open type

货号	中心距	边距	方舌	斜舌	方孔	外箱尺寸	数量/箱	毛重/箱	
	CENTRE	BACK SIDE	DEAD BOLT	LATCH	SPINDLE HOLE	MEAS.	QTY/CTN	G.WT	
	(mm)	(mm)	MATERIAL	MATERIAL	MATERIAL	side length	(PCS)	(KGS)	
745-3R	85	45	3 ROD	zinc/brass	iron powder	8x8	49x27x17	30	19

745R-3R

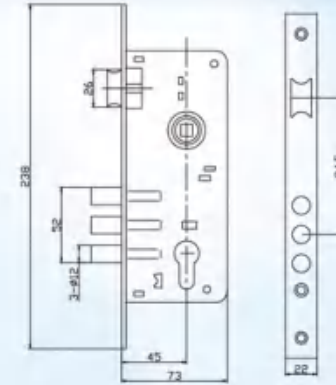

\*open type

货号	中心距	边距	方舌	斜舌	方孔	外箱尺寸	数量/箱	毛重/箱	
	CENTRE	BACK SIDE	DEAD BOLT	LATCH	SPINDLE HOLE	MEAS.	QTY/CTN	G.WT	
	(mm)	(mm)	MATERIAL	MATERIAL	MATERIAL	side length	(PCS)	(KGS)	
745R-3R	85	45	3 ROD	zinc/brass	zinc	8x8	49x27x17	30	19.5

745R-E

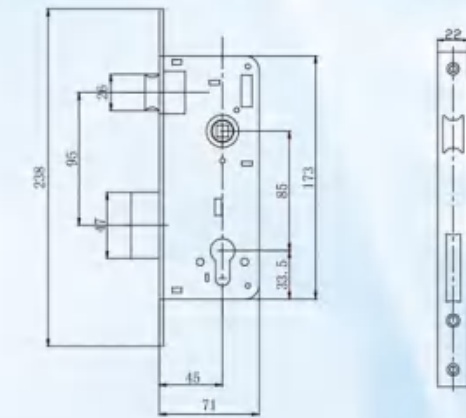

\*open type

货号	中心距	边距	方舌	斜舌	方孔	外箱尺寸	数量/箱	毛重/箱	
	CENTRE	BACK SIDE	DEAD BOLT	LATCH	SPINDLE HOLE	MEAS.	QTY/CTN	G.WT	
	(mm)	(mm)	MATERIAL	MATERIAL	MATERIAL	side length	(PCS)	(KGS)	
745R-E	85	45	iron/brass	zinc/brass	zinc	8x8	49x27x17	30	21

745-3F

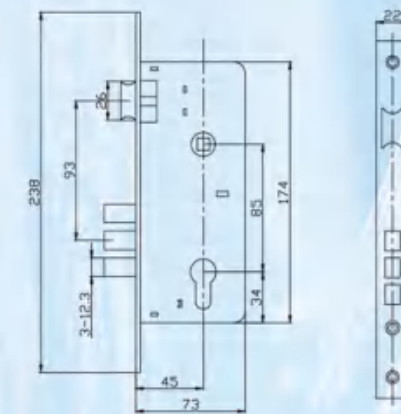

\*open type

货号	中心距	边距	方舌	斜舌	方孔	外箱尺寸	数量/箱	毛重/箱	
	CENTRE	BACK SIDE	DEAD BOLT	LATCH	SPINDLE HOLE	MEAS.	QTY/CTN	G.WT	
	(mm)	(mm)	MATERIAL	MATERIAL	MATERIAL	side length	(PCS)	(KGS)	
745-3F	85	45	3 SQUARE ROD iron/brass	zinc/brass	iron powder	8x8	44x26x16	30	18.5



### 745R-3F

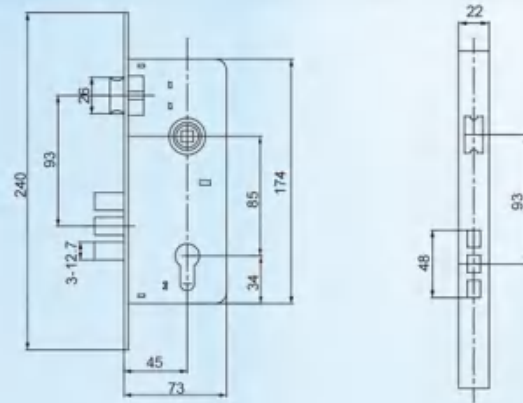
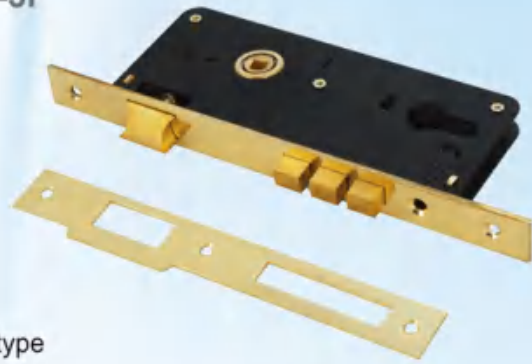

\*open type

货号	中心距	边距	方舌	斜舌	方孔	外箱尺寸	数量/箱	毛重/箱	
	CENTRE	BACK SIDE	DEAD BOLT	LATCH	SPINDLE HOLE	MEAS.	QTY/CTN	G.WT	
	(mm)	(mm)	MATERIAL	MATERIAL	MATERIAL	side length	(PCS)	(KGS)	
745R-3F	85	45	3 SQUARE ROD Iron/brass	zinc/brass	zinc	8x8	44x26x16	30	19

### 745-II

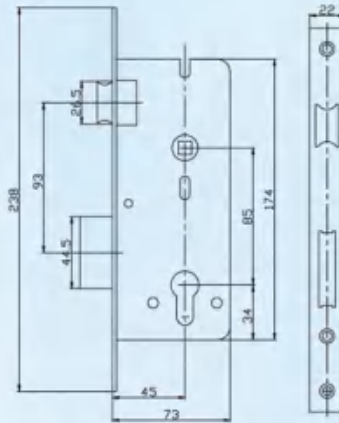

\*open type

货号	中心距	边距	方舌	斜舌	方孔	外箱尺寸	数量/箱	毛重/箱	
	CENTRE	BACK SIDE	DEAD BOLT	LATCH	SPINDLE HOLE	MEAS.	QTY/CTN	G.WT	
	(mm)	(mm)	MATERIAL	MATERIAL	MATERIAL	side length	(PCS)	(KGS)	
745-II	85	45	iron/brass	zinc/brass	iron powder	8x8	44x26x16	30	19

### 740BB

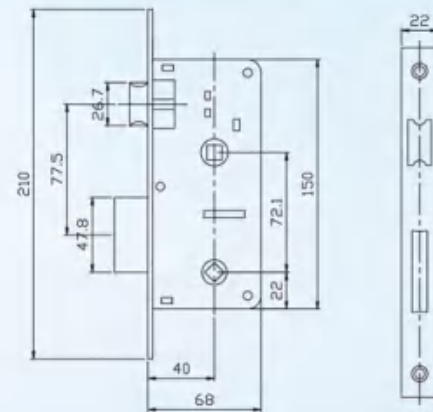

\*open type

货号	中心距	边距	方舌	斜舌	方孔	外箱尺寸	数量/箱	毛重/箱	
	CENTRE	BACK SIDE	DEAD BOLT	LATCH	SPINDLE HOLE	MEAS.	QTY/CTN	G.WT	
	(mm)	(mm)	MATERIAL	MATERIAL	MATERIAL	side length	(PCS)	(KGS)	
740BB	72.1	40	iron	zinc/brass	iron powder	8x8.8x8	43x28x19	30	18

### 740BK

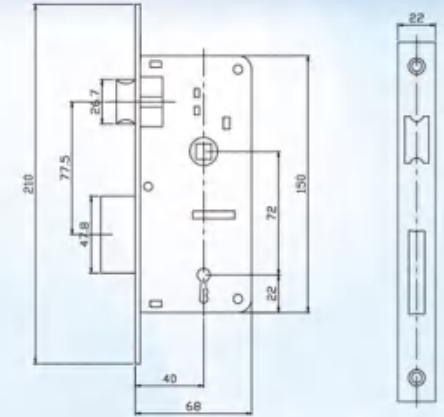
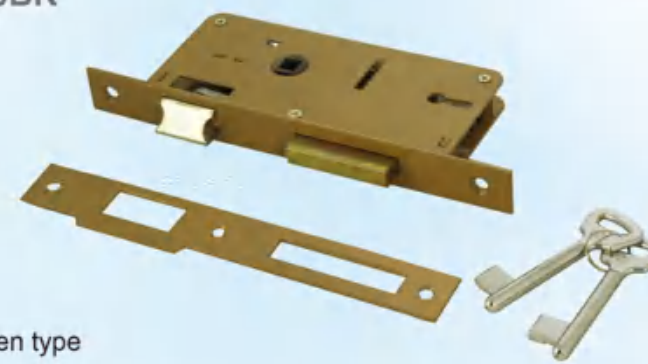

\*open type

货号	中心距	边距	方舌	斜舌	方孔	外箱尺寸	数量/箱	毛重/箱	
	CENTRE	BACK SIDE	DEAD BOLT	LATCH	SPINDLE HOLE	MEAS.	QTY/CTN	G.WT	
	(mm)	(mm)	MATERIAL	MATERIAL	MATERIAL	side length	(PCS)	(KGS)	
740BK	72	40	iron	zinc/brass	iron powder	8x8	43x28x19	30	19

### 740A

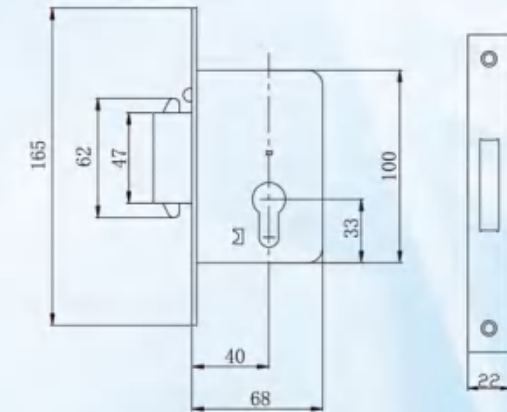
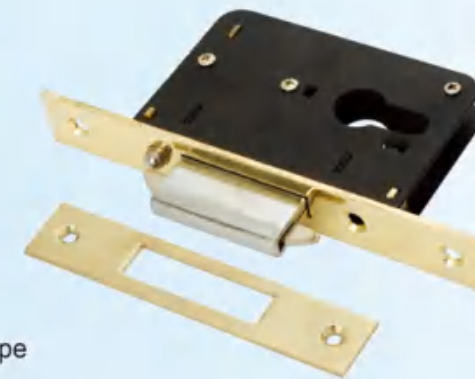

\*open type

货号	中心距	边距	方舌	斜舌	方孔	外箱尺寸	数量/箱	毛重/箱	
	CENTRE	BACK SIDE	DEAD BOLT	LATCH	SPINDLE HOLE	MEAS.	QTY/CTN	G.WT	
	(mm)	(mm)	MATERIAL	MATERIAL	MATERIAL	side length	(PCS)	(KGS)	
740A	/	40	/	iron hook	/	/	45x27x17	30	18

### 7400

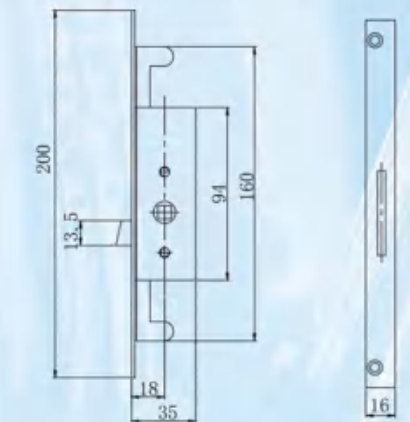

\*close type

货号	中心距	边距	方舌	斜舌	方孔	外箱尺寸	数量/箱	毛重/箱	
	CENTRE	BACK SIDE	DEAD BOLT	LATCH	SPINDLE HOLE	MEAS.	QTY/CTN	G.WT	
	(mm)	(mm)	MATERIAL	MATERIAL	MATERIAL	side length	(PCS)	(KGS)	
7400	/	18	/	zinc hook	zinc	6x6	34.5x21.5x23	100	23.5



751WC  
752WC

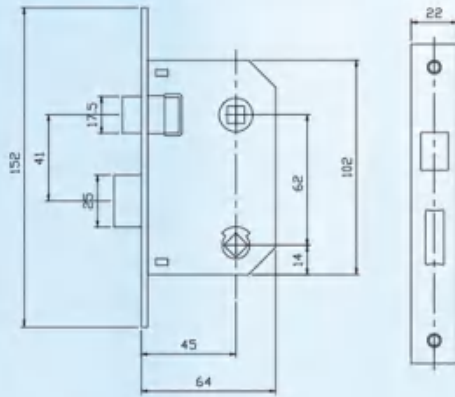
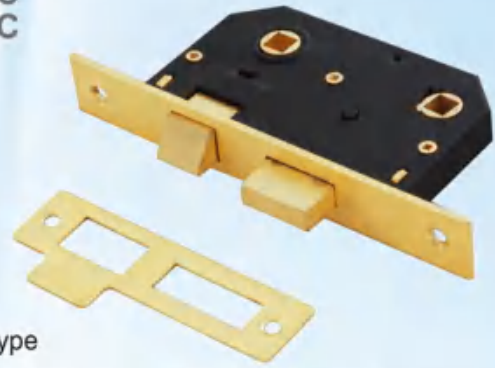

\*close type

货号	中心距	边距	方舌	斜舌	方 孔	外箱尺寸	数量/箱	毛重/箱	
	CENTRE	BACK SIDE	DEAD BOLT	LATCH	SPINDLE HOLE	MEAS.	QTY/CTN	G.WT	
	(mm)	(mm)	MATERIAL	MATERIAL	MATERIAL	side length (CM)	(PCS)	(KGS)	
751WC/ 752WC	62	45	iron/brass	zinc	zinc	8x8,8x8	47x39x16	60	21.5

7704A

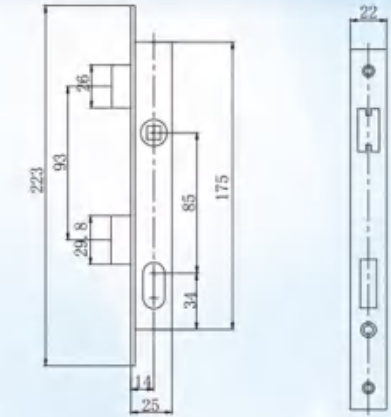

\*open type

货号	中心距	边距	方舌	斜舌	方 孔	外箱尺寸	数量/箱	毛重/箱	
	CENTRE	BACK SIDE	DEAD BOLT	LATCH	SPINDLE HOLE	MEAS.	QTY/CTN	G.WT	
	(mm)	(mm)	MATERIAL	MATERIAL	MATERIAL	side length (CM)	(PCS)	(KGS)	
7704A	85	14	brass	brass	zinc	8x8	34x27x23	48	17

753WC

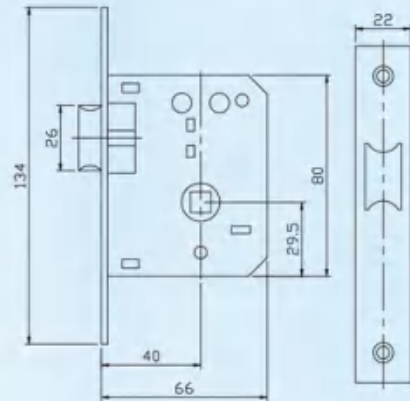
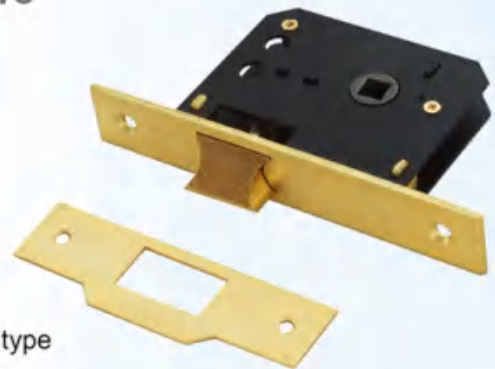

\*open type

货号	中心距	边距	方舌	斜舌	方 孔	外箱尺寸	数量/箱	毛重/箱	
	CENTRE	BACK SIDE	DEAD BOLT	LATCH	SPINDLE HOLE	MEAS.	QTY/CTN	G.WT	
	(mm)	(mm)	MATERIAL	MATERIAL	MATERIAL	side length (CM)	(PCS)	(KGS)	
753WC	/	40	/	zinc/brass	iron powder	8x8	47x39x16	60	19

9010BB-N

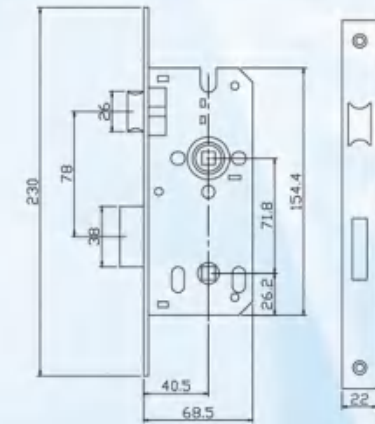
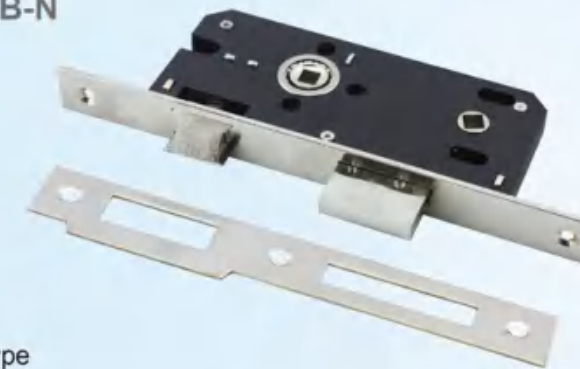

\*close type

货号	中心距	边距	方舌	斜舌	方 孔	外箱尺寸	数量/箱	毛重/箱	
	CENTRE	BACK SIDE	DEAD BOLT	LATCH	SPINDLE HOLE	MEAS.	QTY/CTN	G.WT	
	(mm)	(mm)	MATERIAL	MATERIAL	MATERIAL	side length (CM)	(PCS)	(KGS)	
9010BB-N	71.8	40.5	iron/brass	zinc/brass	zinc	8x8, 6x6	43.5x19x28	30	17

7704

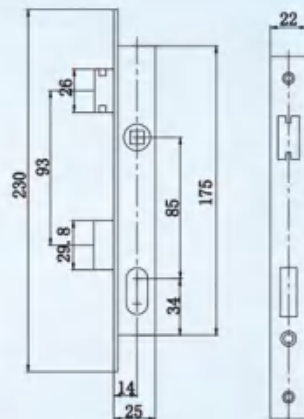

\*open type

货号	中心距	边距	方舌	斜舌	方 孔	外箱尺寸	数量/箱	毛重/箱	
	CENTRE	BACK SIDE	DEAD BOLT	LATCH	SPINDLE HOLE	MEAS.	QTY/CTN	G.WT	
	(mm)	(mm)	MATERIAL	MATERIAL	MATERIAL	side length (CM)	(PCS)	(KGS)	
7704	85	14	brass	brass	zinc	8x8	34x27x23	48	17

9010BK-N

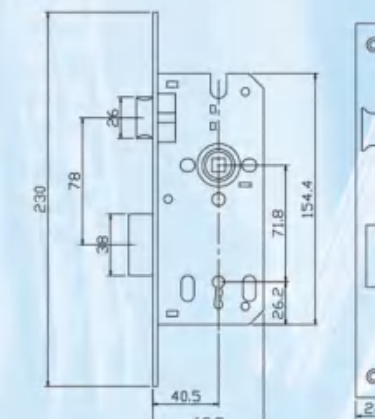

\*close type

货号	中心距	边距	方舌	斜舌	方 孔	外箱尺寸	数量/箱	毛重/箱	
	CENTRE	BACK SIDE	DEAD BOLT	LATCH	SPINDLE HOLE	MEAS.	QTY/CTN	G.WT	
	(mm)	(mm)	MATERIAL	MATERIAL	MATERIAL	side length (CM)	(PCS)	(KGS)	
9010BK-N	71.8	40.5	iron/brass	zinc/brass	zinc	8x8	43.5x19x28	30	18



### 9010BB

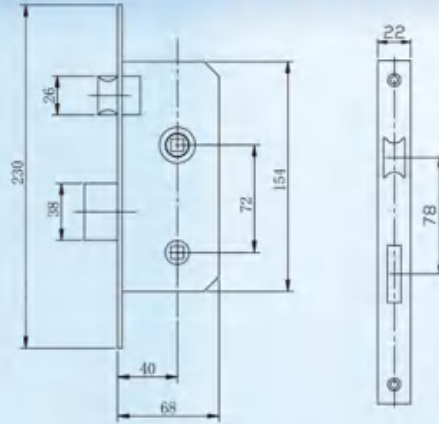
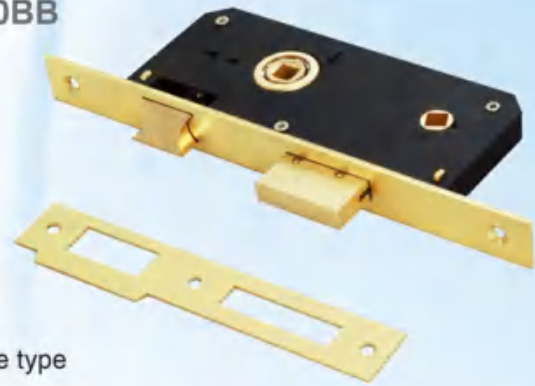

\*close type

货号	中心距	边距	方舌	斜舌	方孔	外箱尺寸	数量/箱	毛重/箱	
	CENTRE	BACK SIDE	DEAD BOLT	LATCH	SPINDLE HOLE	MEAS.	QTY/CTN	G.WT	
	(mm)	(mm)	MATERIAL	MATERIAL	MATERIAL	side length (CM)	(PCS)	(KGS)	
9010BB	72	40	iron/brass	zinc/brass	zinc	8x8, 6x6	43.5x19x28	30	17.5

### 9011S-3R-1

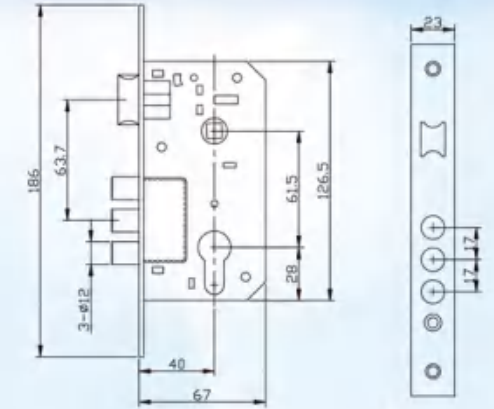

\*close type

货号	中心距	边距	方舌	斜舌	方孔	外箱尺寸	数量/箱	毛重/箱	
	CENTRE	BACK SIDE	DEAD BOLT	LATCH	SPINDLE HOLE	MEAS.	QTY/CTN	G.WT	
	(mm)	(mm)	MATERIAL	MATERIAL	MATERIAL	side length (CM)	(PCS)	(KGS)	
9011S-3R-1	61.5	40	3 ROD	brass	zinc	8x8	39x29x13	30	13.5

### 9010BK

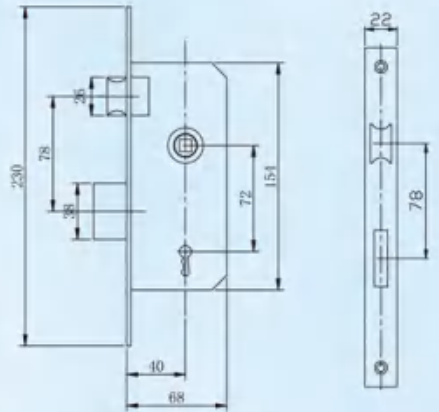

\*close type

货号	中心距	边距	方舌	斜舌	方孔	外箱尺寸	数量/箱	毛重/箱	
	CENTRE	BACK SIDE	DEAD BOLT	LATCH	SPINDLE HOLE	MEAS.	QTY/CTN	G.WT	
	(mm)	(mm)	MATERIAL	MATERIAL	MATERIAL	side length (CM)	(PCS)	(KGS)	
9010BK	72	40	iron/brass	zinc/brass	zinc	8x8	43.5x19x28	30	18.5

### 9011SR-3R

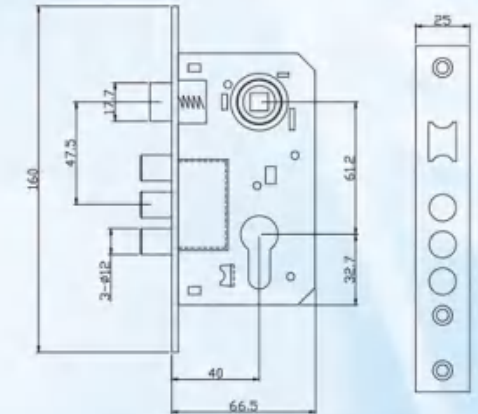

\*close type

货号	中心距	边距	方舌	斜舌	方孔	外箱尺寸	数量/箱	毛重/箱	
	CENTRE	BACK SIDE	DEAD BOLT	LATCH	SPINDLE HOLE	MEAS.	QTY/CTN	G.WT	
	(mm)	(mm)	MATERIAL	MATERIAL	MATERIAL	side length (CM)	(PCS)	(KGS)	
9011SR-3R	61.2	40	3 ROD	brass	zinc	8x8	39x29x13	30	14

### 9011SR

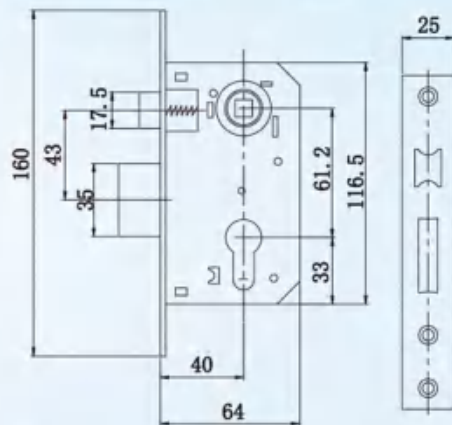
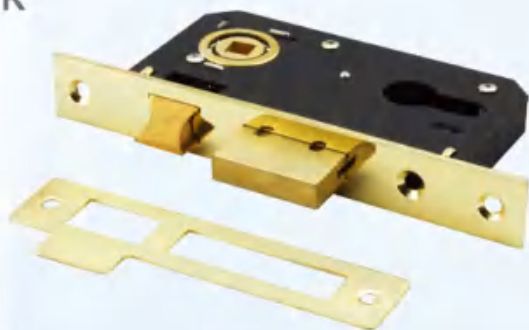

\*close type

货号	中心距	边距	方舌	斜舌	方孔	外箱尺寸	数量/箱	毛重/箱	
	CENTRE	BACK SIDE	DEAD BOLT	LATCH	SPINDLE HOLE	MEAS.	QTY/CTN	G.WT	
	(mm)	(mm)	MATERIAL	MATERIAL	MATERIAL	side length (CM)	(PCS)	(KGS)	
9011SR	61.2	40	iron/brass	brass	iron	8x8	39x29x13	30	13.5

### 9011-40

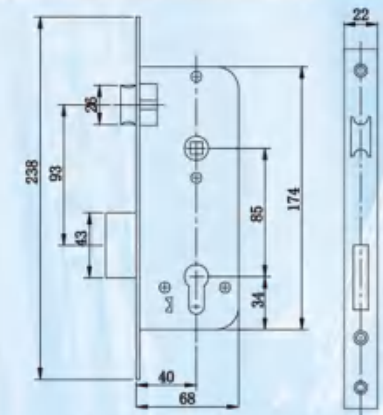

\*close type

货号	中心距	边距	方舌	斜舌	方孔	外箱尺寸	数量/箱	毛重/箱	
	CENTRE	BACK SIDE	DEAD BOLT	LATCH	SPINDLE HOLE	MEAS.	QTY/CTN	G.WT	
	(mm)	(mm)	MATERIAL	MATERIAL	MATERIAL	side length (CM)	(PCS)	(KGS)	
9011-40	85	40	iron/brass	zinc/brass	iron powder	8x8	53x29x14	30	21



## 9045-45

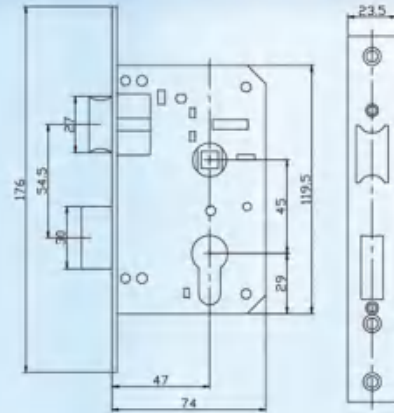
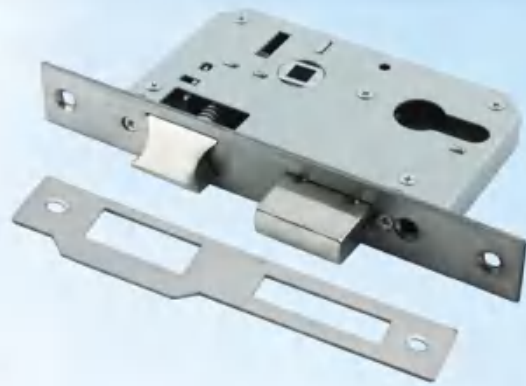

\*close type

货号	中心距	边距	方舌	斜舌	方孔	外箱尺寸	数量/箱	毛重/箱
	CENTRE	BACK SIDE	DEAD BOLT	LATCH	SPINDLE HOLE	MEAS.	QTY/CTN	G.WT
	(mm)	(mm)	MATERIAL	MATERIAL	MATERIAL	side length	(PCS)	(KGS)
9045-45	45	47	Iron/brass	zinc/brass	iron	8x8	40	20.5

## 935R 940R 945R

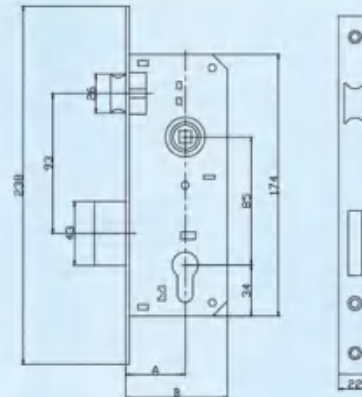

\*close type

A	35	40	45
B	63	68	73

货号	中心距	边距	方舌	斜舌	方孔	外箱尺寸	数量/箱	毛重/箱	
	CENTRE	BACK SIDE	DEAD BOLT	LATCH	SPINDLE HOLE	MEAS.	QTY/CTN	G.WT	
	(mm)	(mm)	MATERIAL	MATERIAL	MATERIAL	side length	(PCS)	(KGS)	
935R	85	35	iron/brass	zinc/brass	zinc	8x8	49x29x17	30	18
940R	85	40	iron/brass	zinc/brass	zinc	8x8	49x29x17	30	19.5
945R	85	45	iron/brass	zinc/brass	zinc	8x8	49x29x17	30	20.5

## 940R-N 945R-N

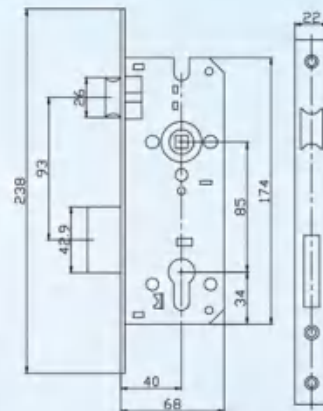
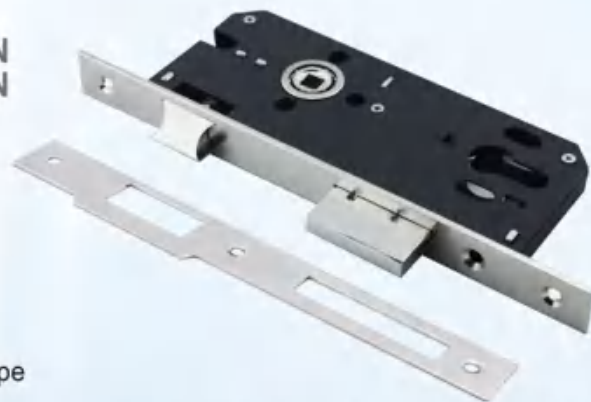

\*close type

A	40	45
B	68	73

货号	中心距	边距	方舌	斜舌	方孔	外箱尺寸	数量/箱	毛重/箱	
	CENTRE	BACK SIDE	DEAD BOLT	LATCH	SPINDLE HOLE	MEAS.	QTY/CTN	G.WT	
	(mm)	(mm)	MATERIAL	MATERIAL	MATERIAL	side length	(PCS)	(KGS)	
940R-N	85	40	iron/brass	zinc/brass	zinc	8x8	49x27x17	30	19
945R-N	85	45	iron/brass	zinc/brass	zinc	8x8	49x27x17	30	19.5

## 935R-3R 945R-3R

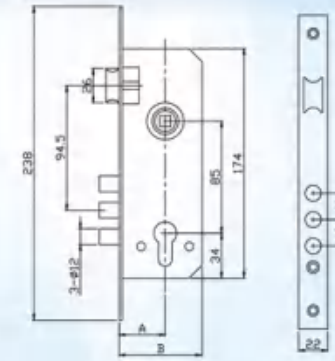

\*close type

A	35	45
B	63	73

货号	中心距	边距	方舌	斜舌	方孔	外箱尺寸	数量/箱	毛重/箱	
	CENTRE	BACK SIDE	DEAD BOLT	LATCH	SPINDLE HOLE	MEAS.	QTY/CTN	G.WT	
	(mm)	(mm)	MATERIAL	MATERIAL	MATERIAL	side length	(PCS)	(KGS)	
935R-3R	85	35	3 ROD	zinc/brass	zinc	8x8	49x27x17	30	18.5
945R-3R	85	45	3 ROD	zinc/brass	zinc	8x8	49x27x17	30	20.5

## 940 945

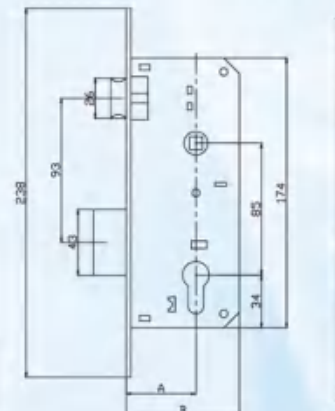

\*close type

A	40	45
B	68	73

货号	中心距	边距	方舌	斜舌	方孔	外箱尺寸	数量/箱	毛重/箱	
	CENTRE	BACK SIDE	DEAD BOLT	LATCH	SPINDLE HOLE	MEAS.	QTY/CTN	G.WT	
	(mm)	(mm)	MATERIAL	MATERIAL	MATERIAL	side length	(PCS)	(KGS)	
945	85	45	iron/brass	zinc/brass	iron powder	8x8	49x27x17	30	20
940	85	40	iron/brass	zinc/brass	iron powder	8x8	49x27x17	30	19.5

## 945-3R

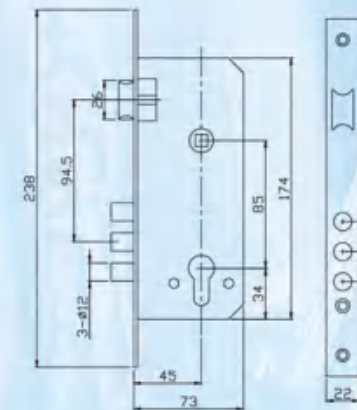

\*close type

货号	中心距	边距	方舌	斜舌	方孔	外箱尺寸	数量/箱	毛重/箱	
	CENTRE	BACK SIDE	DEAD BOLT	LATCH	SPINDLE HOLE	MEAS.	QTY/CTN	G.WT	
	(mm)	(mm)	MATERIAL	MATERIAL	MATERIAL	side length	(PCS)	(KGS)	
945-3R	85	45	3 ROD	zinc/brass	iron powder	8x8	49x27x17	30	20.5



945-11A

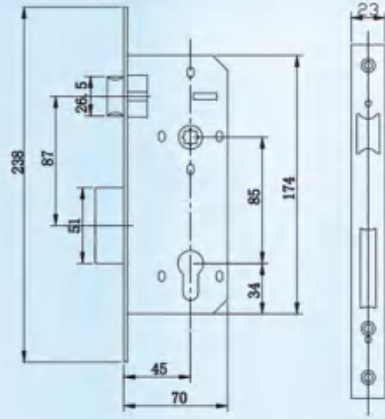
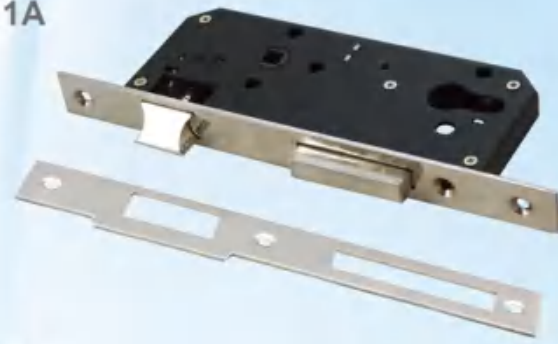

\*close type

货号	中心距	边距	方舌	斜舌	方孔	外箱尺寸	数量/箱	毛重/箱	
	CENTRE	BACK SIDE	DEAD BOLT	LATCH	SPINDLE HOLE	MEAS.	QTY/CTN	G.WT	
	(mm)	(mm)	MATERIAL	MATERIAL	MATERIAL	side length	(PCS)	(KGS)	
945-11A	85	45	iron/brass	zinc/brass	iron powder	8x8	49x27x17	30	20

945-11B-3R

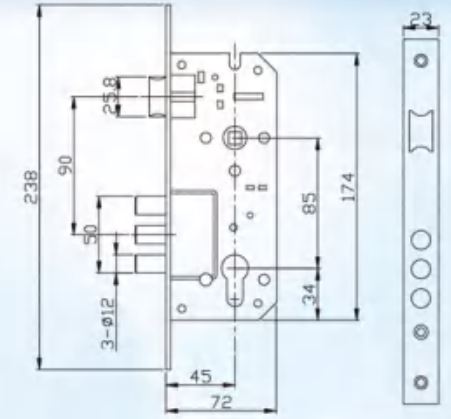

\*close type

货号	中心距	边距	方舌	斜舌	方孔	外箱尺寸	数量/箱	毛重/箱	
	CENTRE	BACK SIDE	DEAD BOLT	LATCH	SPINDLE HOLE	MEAS.	QTY/CTN	G.WT	
	(mm)	(mm)	MATERIAL	MATERIAL	MATERIAL	side length	(PCS)	(KGS)	
945-11B-3R	85	45	3 SQUARE ROD iron/brass	zinc/brass	zinc	8X8	49x27x17	30	21

945-11A-3F

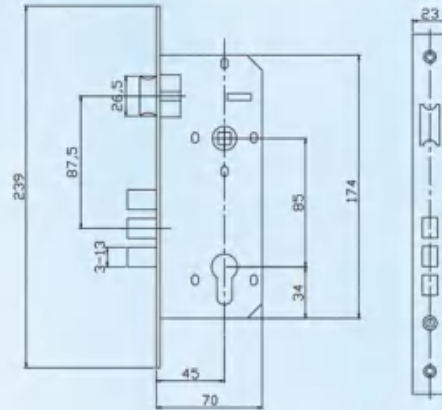
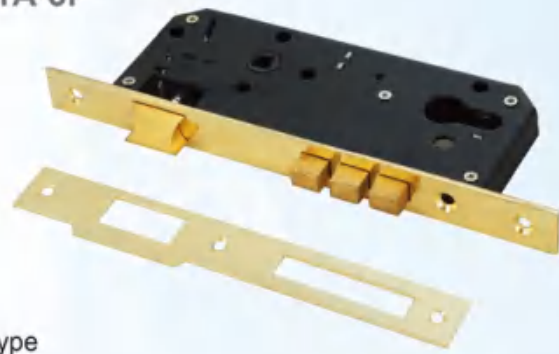

\*close type

货号	中心距	边距	方舌	斜舌	方孔	外箱尺寸	数量/箱	毛重/箱	
	CENTRE	BACK SIDE	DEAD BOLT	LATCH	SPINDLE HOLE	MEAS.	QTY/CTN	G.WT	
	(mm)	(mm)	MATERIAL	MATERIAL	MATERIAL	side length	(PCS)	(KGS)	
945-11A-3F	85	45	3 SQUARE ROD iron/brass	zinc/brass	iron powder	8x8	49x27x17	30	20

945-3FC

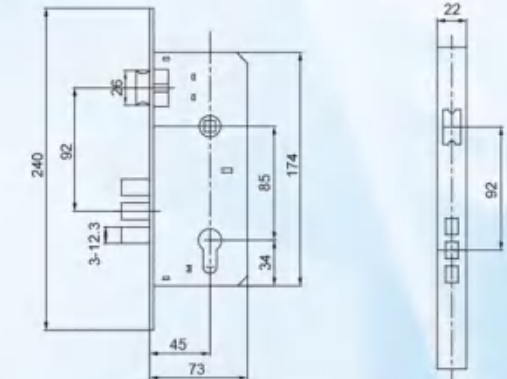

\*close type

货号	中心距	边距	方舌	斜舌	方孔	外箱尺寸	数量/箱	毛重/箱	
	CENTRE	BACK SIDE	DEAD BOLT	LATCH	SPINDLE HOLE	MEAS.	QTY/CTN	G.WT	
	(mm)	(mm)	MATERIAL	MATERIAL	MATERIAL	side length	(PCS)	(KGS)	
945-3FC	85	45	3 SQUARE ROD iron/brass	zinc/brass	iron powder	8x8	49x27x17	30	20

945-11B

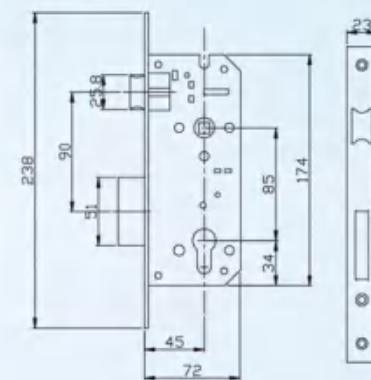
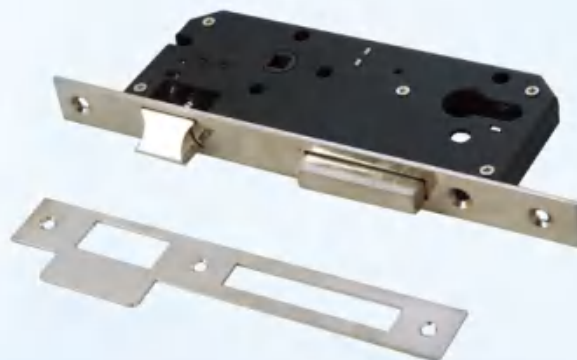

\*close type

货号	中心距	边距	方舌	斜舌	方孔	外箱尺寸	数量/箱	毛重/箱	
	CENTRE	BACK SIDE	DEAD BOLT	LATCH	SPINDLE HOLE	MEAS.	QTY/CTN	G.WT	
	(mm)	(mm)	MATERIAL	MATERIAL	MATERIAL	side length	(PCS)	(KGS)	
945-11B	85	45	iron/brass	zinc/brass	iron powder	8X8	49x27x17	30	19

945-III

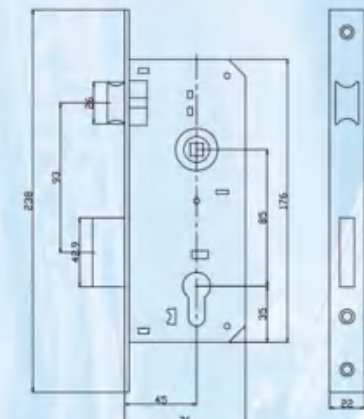
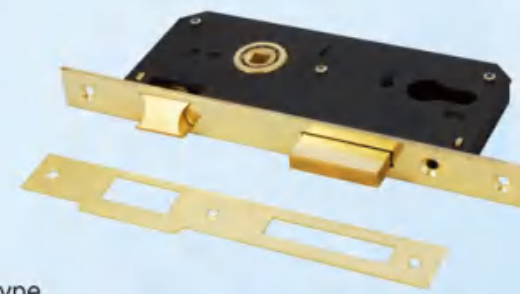

\*close type

货号	中心距	边距	方舌	斜舌	方孔	外箱尺寸	数量/箱	毛重/箱	
	CENTRE	BACK SIDE	DEAD BOLT	LATCH	SPINDLE HOLE	MEAS.	QTY/CTN	G.WT	
	(mm)	(mm)	MATERIAL	MATERIAL	MATERIAL	side length	(PCS)	(KGS)	
945-III	85	45	iron/brass	zinc/brass	zinc	8x8	49x27x17	30	20.5



## 953WC(416.53)

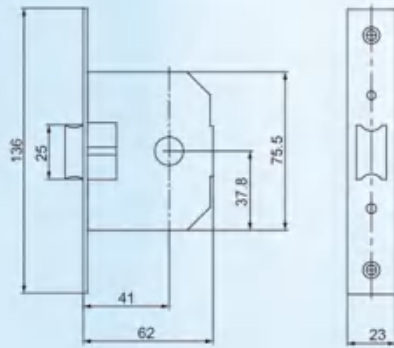

\*close type

货号	中心距	边距	方舌	斜舌	方孔	外箱尺寸	数量/箱	毛重/箱
	CENTRE	BACK SIDE	DEAD BOLT	LATCH	SPINDLE HOLE	MEAS.	QTY/CTN	G.WT
	(mm)	(mm)	MATERIAL	MATERIAL	MATERIAL	side length	(PCS)	(KGS)
953WC	/	41	/	zinc/brass	zinc	6X6	60	16

## 9215

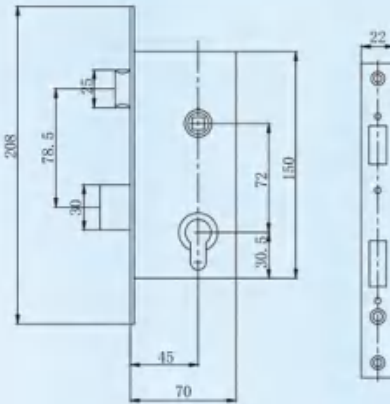

\*close type

货号	中心距	边距	方舌	斜舌	方孔	外箱尺寸	数量/箱	毛重/箱	
	CENTRE	BACK SIDE	DEAD BOLT	LATCH	SPINDLE HOLE	MEAS.	QTY/CTN	G.WT	
	(mm)	(mm)	MATERIAL	MATERIAL	MATERIAL	side length	(PCS)	(KGS)	
9215	72	45	iron	zinc	zinc	8x8	45x29x14	30	17

## 9216

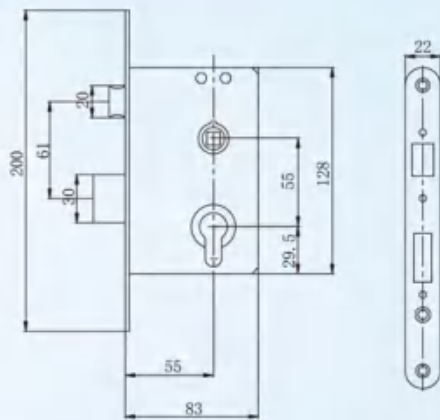

\*close type

货号	中心距	边距	方舌	斜舌	方孔	外箱尺寸	数量/箱	毛重/箱	
	CENTRE	BACK SIDE	DEAD BOLT	LATCH	SPINDLE HOLE	MEAS.	QTY/CTN	G.WT	
	(mm)	(mm)	MATERIAL	MATERIAL	MATERIAL	side length	(PCS)	(KGS)	
9216	55	55	iron	zinc	zinc	8x8	45x29x14	30	17

## 9218N

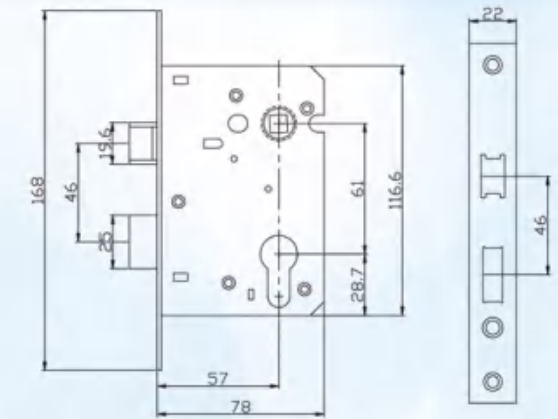
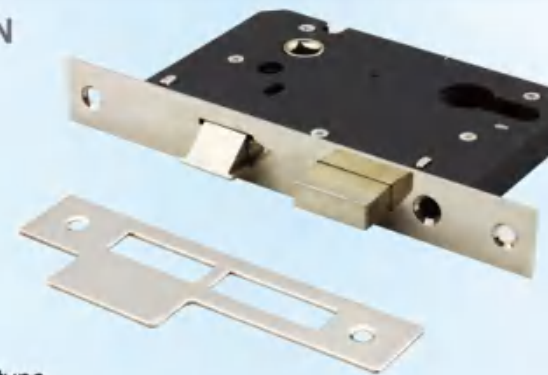

\*close type

货号	中心距	边距	方舌	斜舌	方孔	外箱尺寸	数量/箱	毛重/箱	
	CENTRE	BACK SIDE	DEAD BOLT	LATCH	SPINDLE HOLE	MEAS.	QTY/CTN	G.WT	
	(mm)	(mm)	MATERIAL	MATERIAL	MATERIAL	side length	(PCS)	(KGS)	
9218N	61	57	iron/brass	zinc/brass	zinc	8x8	45x29x14	30	17

## 9219

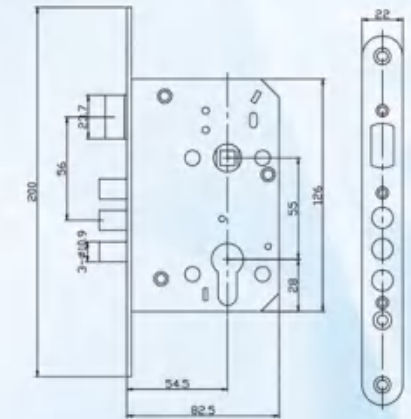

\*close type

货号	中心距	边距	方舌	斜舌	方孔	外箱尺寸	数量/箱	毛重/箱	
	CENTRE	BACK SIDE	DEAD BOLT	LATCH	SPINDLE HOLE	MEAS.	QTY/CTN	G.WT	
	(mm)	(mm)	MATERIAL	MATERIAL	MATERIAL	side length	(PCS)	(KGS)	
9219	55	54.5	3 ROD	zinc	iron powder	8x8	45x29x14	30	17.5

## 968-45 968-55

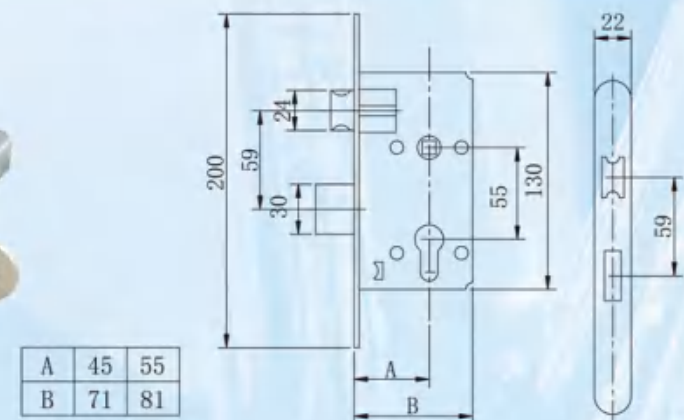
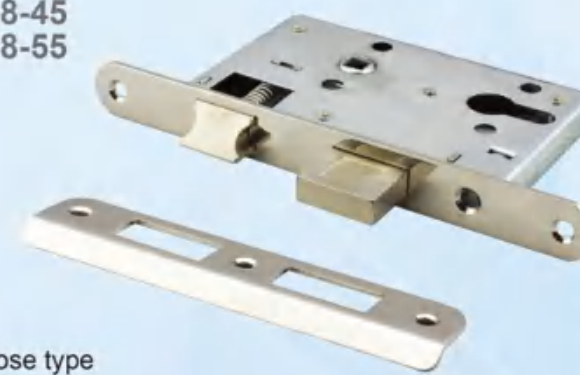

\*close type

货号	中心距	边距	方舌	斜舌	方孔	外箱尺寸	数量/箱	毛重/箱	
	CENTRE	BACK SIDE	DEAD BOLT	LATCH	SPINDLE HOLE	MEAS.	QTY/CTN	G.WT	
	(mm)	(mm)	MATERIAL	MATERIAL	MATERIAL	side length	(PCS)	(KGS)	
968-45	55	45	zinc	zinc	iron	8x8	45x29x14	30	15.5
968-55	55	55	zinc	zinc	iron	8x8	45x29x14	30	16.5



### RL-801/802

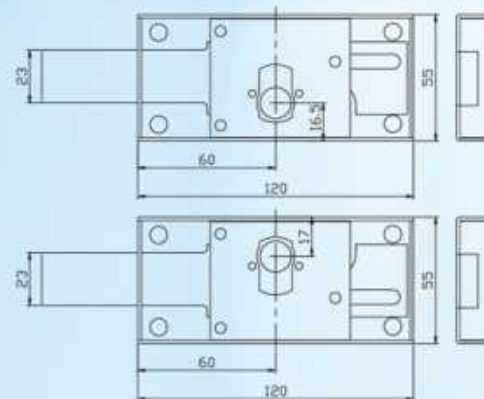

\*close type

货号	中心距	边距	方舌	斜舌	方孔	外箱尺寸	数量/箱	毛重/箱
	CENTRE	BACK SIDE	DEAD BOLT	LATCH	SPINDLE HOLE	MEAS.	QTY/CTN	G.WT
	(mm)	(mm)	MATERIAL	MATERIAL	MATERIAL	side length (CM)	(PCS)	(KGS)
RL-801/802	/	60	iron	/	/	36x28x21	30	25

### RL-803

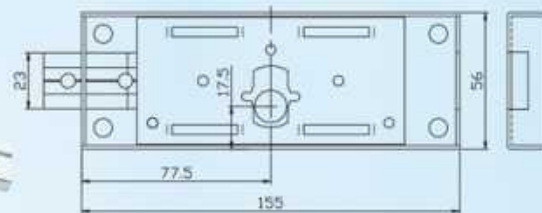

\*close type

货号	中心距	边距	方舌	斜舌	方孔	外箱尺寸	数量/箱	毛重/箱
	CENTRE	BACK SIDE	DEAD BOLT	LATCH	SPINDLE HOLE	MEAS.	QTY/CTN	G.WT
	(mm)	(mm)	MATERIAL	MATERIAL	MATERIAL	side length (CM)	(PCS)	(KGS)
RL-803	/	77.5	iron	/	/	36x28x21	30	18

### 6025D

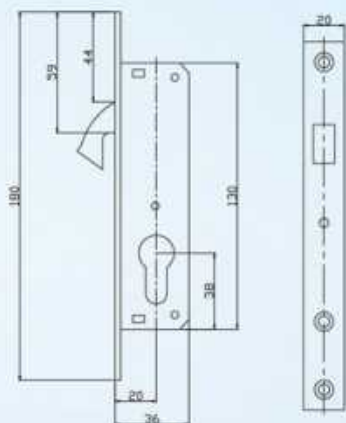

\*open type

货号	中心距	边距	方舌	斜舌	方孔	外箱尺寸	数量/箱	毛重/箱
	CENTRE	BACK SIDE	DEAD BOLT	LATCH	SPINDLE HOLE	MEAS.	QTY/CTN	G.WT
	(mm)	(mm)	MATERIAL	MATERIAL	MATERIAL	side length (CM)	(PCS)	(KGS)
6025D	/	20	/	zinc hook	/	33x21x21	30	11



A



B



C



D



F



G



H



I



## 锁体面板/Front Plate Finish



红古铜 AC  
Antique Copper



镀镍 BN  
Bright Nickel



青古铜 AB  
Antique Brass



不锈钢色 SS  
Stainless Steel



沙丁镍 SN  
Satin Nickel



镀铬 CP  
Chrome Plated



仿金 GP  
Golden Plated



拉丝镀铬 BCP  
Brushed Chrome Plated



仿金拉丝 BGP  
Brushed Golden Plated



拉丝镀镍 BNP  
Brushed Nickel Plated



暗镀镍拉丝 BNDP  
Brushed Nickel Dark Plated



铜拉丝 BBP  
Brushed Brass Plated



沙丁镍拉丝 BSN  
Brushed Santin Nickel

